



**PriceList 2022**  
*Design & Architectural collections*

*Running from 1<sup>st</sup> July 2022*  
*In vigore dal 1 Luglio 2022*



***PriceList 2022***  
*Design & Architectural collections*

*Running from 1<sup>st</sup> July 2022*  
*In vigore dal 1 Luglio 2022*

## Index

<i>pag.</i>			
04	Bic B02	09	J&J
05	Bic B07	09	Jumbo
05	Bic B12	10	MoMa mono-color Ø40,0 - Ø60,0
06	Brick	10	MoMa P mono-color Ø40,0 - Ø60,0
06	Box	11	MoMa bi-color Ø40,0 - Ø60,0
07	micro-Box	12	MoMa L/M bi-color Ø40,0 - Ø60,0
07	Club C1 mono - color	13	MoMa P bi-color Ø40,0 - Ø60,0
07	Club C2 mono - color	13	MoMa W bi-color Ø40,0 - Ø60,0
07	Club C3 mono - color	13	Nelly
23	Easy Pop P00 Ø3,0	13	Nemo
23	Easy Pop P00 NaNo Ø3,0	14	Pop Bijou
31	Easy Pop P01 Bulb	20	Pop Bon Bon
25	Easy Pop P01 Ø4,0	14	Pop C'est Moi
28	Easy Pop P01 Ø5,5	15	Pop C'est Toi
33	Easy Pop P02 Ø5,5	16	Pop Chapeau
29	Easy Pop P01 NaNo Ø5,5	15	Pop Chérie
38	Easy Pop P03 Ø8,0	18	Pop Petit
39	Easy Pop P03 NaNo Ø8,0	73	Pop Host bi-color Ø32,0
51	Easy Pop P04 Ø8,0	72	Pop Host mono-color Ø32,0
42	Easy Pop PX3 Ø10,0	75	Pop Host L/M bi-color Ø32,0
43	Easy Pop PX3 NaNo Ø10,0	75	Pop Host T/N bi-color Ø32,0
45	Easy Pop PY3 Ø10,0	74	Pop Host W bi-color Ø32,0
45	Easy Pop PY3 NaNo Ø10,0	73	Pop Host bi-color Ø80,0
47	Easy Pop PY3 Ø10,0 Glass	72	Pop Host mono-color Ø80,0
47	Easy Pop PY3 NaNo Ø10,0 Glass	74	Pop Host W bi-color Ø80,0
49	Easy Pop PZ3 Ø10,0	22	Pop P00 Ø3,0
08	e-Pad 15	22	Pop P00 NaNo Ø3,0
08	e-Pad 30	30	Pop P01 Bulb
17	<i>Filo System:</i> Bijou - C'est Moi C'est Toi - Chérie Chapeau	24	Pop P01 Ø4,0
21	<i>Filo System</i> Bon Bon	26	Pop P01 Ø5,5
19	<i>Filo System</i> Pop Petit	27	Pop P01 NaNo Ø5,5
90	<i>Gun 2 A</i>	32	Pop P02 Ø5,5
90	<i>Gun 2 B</i>	34	Pop P03 Ø6,0
91	<i>Gun 2 C</i>	35	Pop P03 NaNo Ø6,0
91	<i>Gun 2 W</i>	36	Pop P03 Ø8,0
		37	Pop P03 NaNo Ø8,0
		50	Pop P03 Look Ø17,0
		40	Pop PX3 Ø10,0
		41	Pop PX3 NaNo Ø10,0
		44	Pop PY3 Ø10,0
		44	Pop PY3 NaNo Ø10,0
		46	Pop PY3 Ø10,0 Glass
		46	Pop PY3 NaNo Ø10,0 Glass
		48	Pop PZ3 Ø10,0
		51	Pop P04 Ø8,0
		52	Pop P04 Ø12,0
		53	Pop P04 Magic A-B Ø3,0
		54	Pop P04 Magic C Ø3,0
		54	Pop P04K Magic Ø3,0
		55	Pop P06 mono-color Ø6,0
		56	Pop P06 bi-color Ø6,0
		55	Pop P07 mono-color Ø6,0
		56	Pop P07 bi-color Ø6,0
		57	Pop PX7 Ø11,2
		58	Pop P07 Bulb
		59	Pop P07 Pull Ø12,5
		59	Pop Ring Pull Ø12,5
		60	Pop P10
		62	Pop P12 Ø3,0
		61	Pop P12 D Ø3,0
		63	Pop P12 L Ø3,0
		62	Pop P12 T Ø3,0
		63	Pop P12 K Ø3,0
		64	Pop P12 Ø7,0
		64	Pop P12 Ø12,5
		65	Pop P12 Cup Ø3,0
		66	Pop P12 Cup Ø6,0
		67	Pop P12 Cup Ø12,0
		68	Pop P12 Polifemo PF1
		68	Pop P12 Polifemo PF3
		65	Pop P12 Ring Ø3,0
		66	Pop P12 Ring Ø6,0
		67	Pop P12 Ring Ø12,0
		65	Pop P12 W Ø3,0
		69	Pop P13 Ø7,0
		69	Pop P13 Ø12,5
		70-71	Pop P15 Ø3,0
		76	Pop P40 A Chandelier
		76	Pop P40 B Chandelier
		77	Pop P40 R Chandelier
		77	Pop P50 Pinocchio
		77	Pop P55 Pinocchio
		79	Pop P120 - P200
		78	Pop P122 - P202 Brooklyn
		80	Pop Up 1
		80	Pop Up 207
		81	Tim T124 - T196
		82	X1 A Ø7,0
		83	X1 B Ø8,5
		84	X2 A Ø7,0
		85	X2 B Ø8,5
		86	X3 A Ø7,0
		87	X3 B Ø8,5
		88	X4 A 7,0x7,0
		89	X4 B 8,5x8,5
		92	X5 B
		93	X7 R
		93	X7 C
		99	X-Dark 1
		98	X-Gun 1 Ø3,0
		98	X-Gun 2 Ø4,3
		98	X-Gun 3 Ø5,0
		98	X-Gun 4 Ø6,0
		100	X-Line
		94	X-Rail magnet track
		101	X-Rail Pendant/Sospensione
		102	X-Rail Accessories/Accessori
		104	X - Running

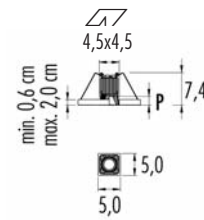
Bic 02 5x5 with trim **ROS**

For plasterboard. Per cartongesso

IP40	MC-E=3	CE	CE	CE	CE
500m/A	LED 6W	CRI>90			
<b>3B02.2</b> ■ S. □	P = 2,0cm	€ 120,00			
<b>4B02.2</b> ■ S. □	P = 1,5cm	€ 125,00			
<i>With honeycomb. Con frangiluce</i>					
■ Led color	Nominal lm	Beam spread			
2 = 2700K	528	22°			
3 = 3000K	552				
4 = 4000K	594				

IP54	MC-E=3	CE	CE	CE	CE
500m/A	LED 6W	CRI>90			
<b>3B02.2</b> ■ S9. □	P = 2,0cm	€ 125,00			
■ Led color	Nominal lm	Beam spread			
2 = 2700K	528	22°			
3 = 3000K	552				
4 = 4000K	594				

© (m-M)	Driver		
<b>3KIT.500.15</b> (1-1)	on/off	€ 30,00	
<b>3KIT.501.50</b> (1-7)	DALI - Push - 1...10V Remote installation	€ 125,00	
<b>3KIT.502.20</b> (1-3)	DALI Remote installation	€ 67,00	
<b>3KIT.503.20</b> (1-3)	Push - 1...10 Remote installation	€ 62,00	
<b>3KIT.504.10</b> (1-1)	IGBT - TRIAC	€ 32,00	

□ Frame - Struttura

- 02 ● Black - Nero  
06 ○ White - Bianco

(m-M) = min. Led unit - Max Led unit. Led and Emergency unit, warranty only when used together with driver bought from Oty srl.

(m-M) = gestione minima e massima delle unità Led. I Led e le unità di emergenza, sono coperti da garanzia solo se utilizzati in abbinamento con i driver forniti dalla Oty srl.

For brickwork. Per laterizio

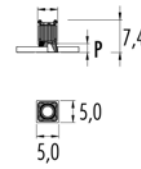

IP40	MC-E=3	CE	CE	CE	CE
500m/A	LED 6W	CRI>90			
<b>3B2M.2</b> ■ S. □	P = 2,0cm	€ 125,00			
<b>4B2M.2</b> ■ S. □	P = 1,5cm	€ 130,00			
<i>With honeycomb. Con frangiluce</i>					
■ Led color	Nominal lm	Beam spread			
2 = 2700K	528	22°			
3 = 3000K	552				
4 = 4000K	594				

IP54	MC-E=3	CE	CE	CE	CE
500m/A	LED 6W	CRI>90			
<b>3B2M.2</b> ■ S9. □	P = 2,0cm	€ 130,00			
■ Led color	Nominal lm	Beam spread			
2 = 2700K	528	22°			
3 = 3000K	552				
4 = 4000K	594				

© (m-M)	Driver		
<b>3KIT.500.15</b> (1-1)	on/off	€ 30,00	

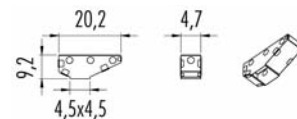

Housing for brickwork - Cassaforma laterizio

<b>1M02.050.01</b>	€ 34,00
--------------------	---------

## Bic 07 7x7 trimless

For plasterboard. Per cartongesso

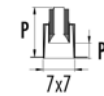

IP20	MC-E=3	CE	CE	CE	CE
220V ÷ 240V					
<b>3B07.210.</b> □	GU10 max 50W	€ 55,00			

IP20	MC-E=3	CE	CE	CE	CE
12V					
<b>3B07.220.</b> □	GU5.3 max 50W	€ 55,00			
<b>3KIT.201.050</b>	max 50VA	€ 35,00			
<i>Dimmable gear: IGBT</i>					

IP40	MC-E=3	CE	CE	CE	CE
350m/A	LED 11W	CRI>90			
<b>3B07.3</b> ■ ■ ■ □		€ 125,00			

■ Led color	Nominal lm	▲ Beam spread
2 = 2700K	1195	S = 22°
3 = 3000K	1257	T = 12°
4 = 4000K	1313	

© (m-M)	Driver		
<b>3KIT.350.1L</b> (1-1)	on/off	€ 21,00	
<b>3KIT.351.40</b> (1-3)	DALI - Push - 1...10V Remote installation	€ 125,00	
<b>3KIT.352.15</b> (1-1)	DALI	€ 67,00	
<b>3KIT.353.15</b> (1-1)	Push - 1...10V	€ 62,00	
<b>3KIT.354.18</b> (1-1)	IGBT - TRIAC	€ 32,00	

Emergency unit: (inverter + battery. Driver not included)

<b>3KIT.900.01</b> (1-1)	1:00 hour	€ 110,00
<b>3KIT.900.03</b> (1-1)	3:00 hours	€ 145,00

IP40	DimToWarm	CE	CE	CE	CE
350m/A	LED 6W	CRI 95			
<b>3B07.3W</b> ■ ■ □		€ 115,00			

■ Led color	Nominal lm	▲ Beam spread
W= max 3000K	max 445 lm	M = 30°
min. 1800K	min. 10 lm	S = 18°

© (m-M)	Driver		
<b>3KIT.352.W15</b> (1-1)	DALI	€ 67,00	
<b>3KIT.354.W10</b> (1-1)	IGBT - TRIAC	€ 30,00	

Housing for plasterboard. Cassaforma per cartongesso

■ <b>1Z07.070.01</b>	Single	€ 35,00
■ <b>1Z07.070.2L</b>	Double	€ 65,00

## Bic 12 12x12 trimless

For plasterboard. Per cartongesso

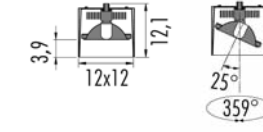

IP20	MC-E=3	CE	CE	CE	CE
350 - 500 m/A	LED	CRI>90			
<b>3B12.5</b> ■ ■ ■ □		€ 170,00			

© (m-M)	LED 12,5W	350m/A	
<b>3KIT.350.1L</b> (1-1)	on/off	€ 21,00	
<b>3KIT.351.40</b> (1-3)	DALI - Push - 1...10V	€ 125,00	
<b>3KIT.352.15</b> (1-1)	DALI	€ 67,00	
<b>3KIT.353.15</b> (1-1)	Push - 1...10V	€ 62,00	
<b>3KIT.354.18</b> (1-1)	IGBT - TRIAC	€ 32,00	
■ Led color	Nominal lm	▲ Beam spread	
2 = 2700K	1477	L = 60°	
3 = 3000K	1565	S = 24°	
4 = 4000K	1635	T = 12°	

© (m-M)	LED 18,4W	500m/A	
<b>3KIT.500.1L</b> (1-1)	on/off	€ 21,00	
<b>3KIT.501.50</b> (1-2)	DALI - Push - 1...10V	€ 125,00	
<b>3KIT.502.20</b> (1-1)	DALI	€ 67,00	
<b>3KIT.503.20</b> (1-1)	Push - 1...10V	€ 62,00	
<b>3KIT.504.20</b> (1-1)	IGBT - Triac	€ 32,00	
■ Led color	Nominal lm	▲ Beam spread	
2 = 2700K	2020	L = 60°	
3 = 3000K	2140	S = 24°	
4 = 4000K	2236	T = 12°	

Emergency unit: (inverter + battery. Driver not included)

<b>3KIT.900.01</b> (1-1)	1:00 hour	€ 110,00
<b>3KIT.900.03</b> (1-1)	3:00 hours	€ 145,00

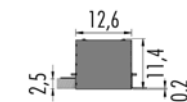

Housing for plasterboard. Cassaforma per cartongesso

<b>1Z12.120.01</b>	€ 50,00
--------------------	---------

**Bric**

wall - parete

**Bric 20**

IP20 ☉	MC-E=3	CE ▽
220-240V	8,5W	CRI>90
<b>3BR2.4</b> ■ L. □	dimm. IGBT - TRIAC	€ <b>260,00</b>
<b>3BR2F4</b> ■ L. □	DALI - Push	€ <b>300,00</b>
■ Led color	Nominal lm	Beam spread
2 = 2700K	1040	92°
3 = 3000K	1095	

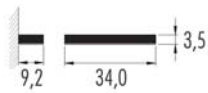
**Bric 34**

IP20 ☉	MC-E=3	CE ▽
220-240V	17W	CRI>90
<b>3BR3.4</b> ■ L. □	on/off	€ <b>350,00</b>
■ Led color	Nominal lm	Beam spread
2 = 2700K	2080	92°
3 = 3000K	2190	

□ Frame - Struttura

- 02 ● Black - Nero  
06 ○ White - Bianco



Code	L	H	P
BOX23	23,0	8,5	7,2
BOX31	31,0	8,5	7,2
BOX50	50,0	8,5	7,2
BOX63	63,0	8,5	7,2

□ Frame - Struttura

- 02 ● Black - Nero  
06 ○ White - Bianco

**Box**

wall - parete

**Box 23 cm**

IP40 ☉	MC-E=3	CE ▽
220-240V	LED 2x6,8W	CRI>95
<b>3B23.5</b> ■ L. □	on/off	€ <b>250,00</b>
■ Led color	Nominal lm	Beam spread
2 = 2700K	2x860	90°
3 = 3000K	2x875	

**Box 31 cm**

IP40 ☉	MC-E=3	CE ▽
220-240V	LED 2x9,0W	CRI>95
<b>3B31.5</b> ■ L. □	on/off	€ <b>280,00</b>
<b>3B31F5</b> ■ L. □	DALI - Push - 1...10V	€ <b>330,00</b>
<b>3B31G5</b> ■ L. □	1...10V - Push	€ <b>330,00</b>
■ Led color	Nominal lm	Beam spread
2 = 2700K	2x1135	90°
3 = 3000K	2x1170	

**Box 50 cm**

IP40 ☉	MC-E=3	CE ▽
220-240V	LED 2x13,5W	CRI>95
<b>3B50.5</b> ■ L. □	on/off	€ <b>350,00</b>
<b>3B50E5</b> ■ L. □	DALI - Push - 1...10V	€ <b>420,00</b>
■ Led color	Nominal lm	Beam spread
2 = 2700K	2x1700	90°
3 = 3000K	2x1756	

**Box 63 cm**

IP40 ☉	MC-E=3	CE ▽
220-240V	LED 2x18,2W	CRI>95
<b>3B63.5</b> ■ L. □	on/off	€ <b>390,00</b>
<b>3B63E5</b> ■ L. □	DALI - Push - 1...10V	€ <b>450,00</b>
■ Led color	Nominal lm	Beam spread
2 = 2700K	2x2270	90°
3 = 3000K	2x2340	

**microBox**

wall - parete



IP20 ☉	CE ▽
220-240V	GU10 2 x lamp led
<b>3B72.210</b> □	€ <b>115,00</b>

□ Frame - Struttura

- 02 ● Black - Nero  
06 ○ White - Bianco

**Club C1 Mono-color**

IP20 ☉	CE ▽	
220-240V	9W CRI>90	
<b>3C1C.2</b> ■ L. □	on/off € <b>480,00</b>	
■ Led color	Nominal lm	Beam spread
2 = 2700K	1008	60°
3 = 3000K	1066	

**Club C2 Mono-color**

IP20 ☉	CE ▽	
220-240V	9W CRI>90	
<b>3C2C.2</b> ■ L. □	on/off € <b>480,00</b>	
■ Led color	Nominal lm	Beam spread
2 = 2700K	1008	60°
3 = 3000K	1066	

**Club C3 Mono-color**

IP20 ☉	CE ▽	
220-240V	9W CRI>90	
<b>3C3C.2</b> ■ L. □	on/off € <b>480,00</b>	
■ Led color	Nominal lm	Beam spread
2 = 2700K	1008	60°
3 = 3000K	1066	

□ Frame - Struttura Canopy - Rosone Wire - Cavo

- 02 ● Black - Nero Black - Nero Black - Nero  
06 ○ White - Bianco White - Bianco Black - Nero

**e-PAD 15**

wall - parete

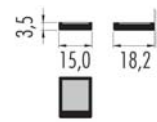

IP20	MC-E=3	CE
220-240V	LED 1x18W	CRI>90
<b>3E15.5</b>	dim. IGBT - TRIAC	€ <b>260,00</b>
■ Led color	Nominal lm	Beam spread
2 = 2700K	2494	105°
3 = 3000K	2611	
4 = 4000K	2697	

**e-PAD 30**

wall - parete

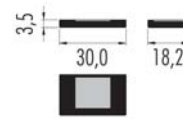

IP20	MC-E=3	CE
220-240V	LED 2x18W	CRI>90
<b>3E30.5</b>	dim. IGBT - TRIAC	€ <b>365,00</b>
<b>3E30.7</b>	DALI - Push - 1...10V	€ <b>430,00</b>
■ Led color	Nominal lm	Beam spread
2 = 2700K	2x2494	105°
3 = 3000K	2x2611	
4 = 4000K	2x2697	

□ Frame - Struttura

02 ● Black - Nero

06 ○ White - Bianco

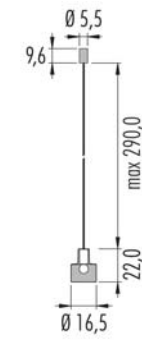
**J & J**

IP20	CE	CE
220-240V	e27 4W	CRI>80
<b>3JJ1.12L.02</b>	dim. IGBT - Triac	€ <b>590,00</b>
■ Led color	Nominal lm	Beam spread
2700K	470	220°

Canopy/Rosone	Wire/Cavo	Cylinder/Cilindro	Glass/Vetro
Black - Nero	Black - Nero	Black - Nero	Fumé - Fumé

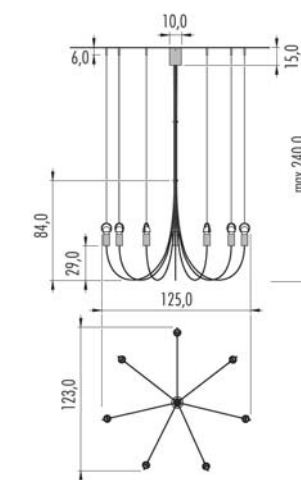
**Jumbo J07**

IP20	CE	CE
220-240V	e27 7x4W	CRI>80
<b>3J07.12L.02</b>	dim. IGBT - Triac	€ <b>1.700,00</b>
■ Led color	Nominal lm	Beam spread
2700K	7x470	360°

Wire - Cavo	Cylinder for Bulb - Cilindro porta-lampada
Black - Nero	Black - Nero

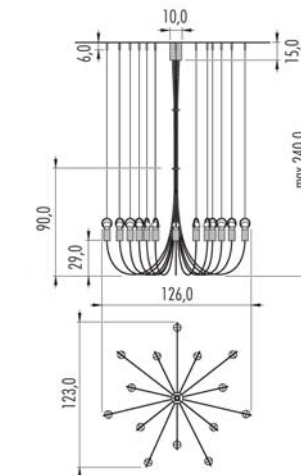
**Jumbo J14**

IP20	CE	CE
220-240V	e27 14x4W	CRI>80
<b>3J14.12L.02</b>	dim. IGBT - Triac	€ <b>2.700,00</b>
■ Led color	Nominal lm	Beam spread
2700K	14x470	360°

Wire - Cavo	Cylinder for Bulb - Cilindro porta-lampada
Black - Nero	Black - Nero

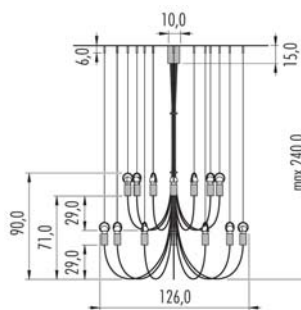

## MoMa Mono-color

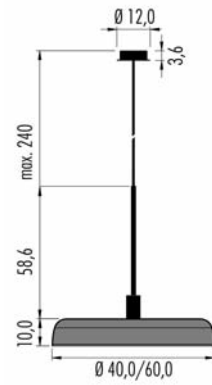

IP20	Ⓛ	CE	▽
220-240V	e27	7W	CRI>80
dimmable IGBT - Triac			
<b>3M40C.12L.06</b>	Ø 40cm	€	<b>470,00</b>
<b>3M60C.12L.06</b>	Ø 60cm	€	<b>600,00</b>
Led color	Nominal lm	Beam spread	
2700K	806	163°	

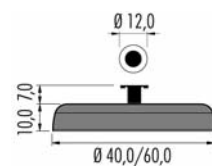
MoMa P Mono-color  
wall/ceiling - parete/plafone

IP20	Ⓛ	CE	▽
220-240V	e27	7W	CRI>80
dimmable IGBT - Triac			
<b>3M40P.12L.06</b>	Ø 40cm	€	<b>400,00</b>
<b>3M60P.12L.06</b>	Ø 60cm	€	<b>520,00</b>
Led color	Nominal lm	Beam spread	
2700K	806	163°	

Frame/Struttura	Bulb/Lampadina
White - Bianco	Mirror chrome - Specchiata cromo

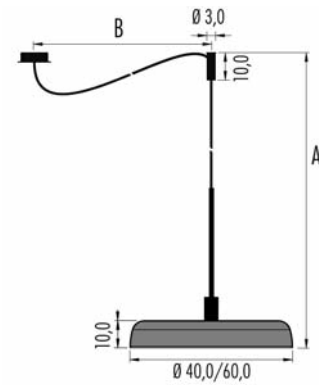

IP20	Ⓛ	A+B=410cm	CE	▽
220-240V	e27	7W	CRI>80	
dimmable IGBT - Triac				
<b>3M40D.12L.06</b>	Ø 40cm	€	<b>570,00</b>	
<b>3M60D.12L.06</b>	Ø 60cm	€	<b>710,00</b>	
Led color	Nominal lm	Beam spread		
2700K	806	163°		

Frame/Struttura	Wire/Cavo	Bulb/Lampadina
White - Bianco	White - Bianco	Mirror chrome - Specchiata cromo

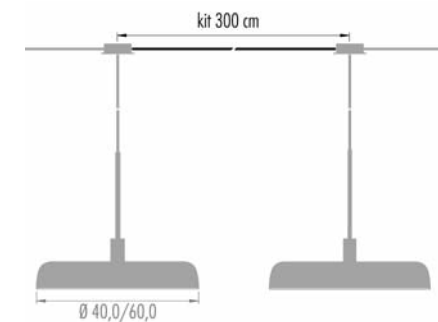

Kit Cable for MoMa composition - Kit cavo per composizione MoMa	White - Bianco	€
<b>1KIT.300.06</b>		<b>36,00</b>

## MoMa Bi-color

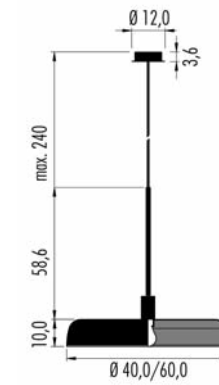

IP20	Ⓛ	CE	▽
220-240V	e27	4W	CRI>80
dimmable IGBT - Triac			
<b>3M40C.12L.□</b>	Ø 40cm	€	<b>660,00</b>
<b>3M60C.12L.□</b>	Ø 60cm	€	<b>800,00</b>
Led color	Nominal lm	Beam spread	
2700K	470	163°	

□	Out	In	Diffuser - Diffusore	Canopy - Rosone
KC	●	●	Black/Copper - Nero/Rame	Black - Nero
WC	○	●	White/Copper - Bianco/Rame	White - Bianco
BC	●	●	Blue/Copper - Blu/Rame	Blue - Blu
GC	●	●	Green/Copper - Verde/Rame	Green - Verde
PC	●	●	Rose/Copper - Rosa/Rame	Rose - Rosa
RC	●	●	Red/Copper - Rosso/Rame	Red - Rosso

Wire/Cavo	Bulb/Lampadina
Copper - Rame	Transparent - Trasparente

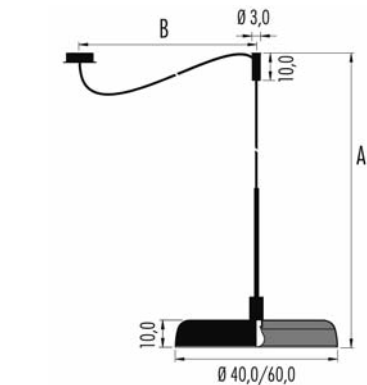

IP20	Ⓛ	A+B=410cm	CE	▽
220-240V	e27	4W	CRI>80	
dimmable IGBT - Triac				
<b>3M40D.12L.□</b>	Ø 40cm	€	<b>790,00</b>	
<b>3M60D.12L.□</b>	Ø 60cm	€	<b>940,00</b>	
Led color	Nominal lm	Beam spread		
2700K	470	163°		

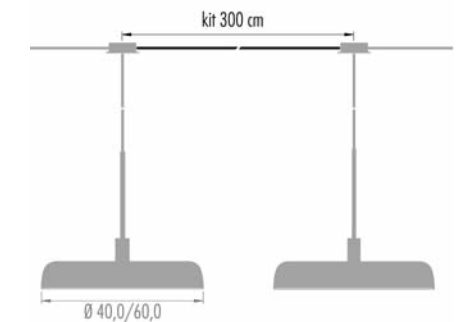

Kit Cable for MoMa composition - Kit cavo per composizione MoMa	Copper - Rame L. 300cm	€
<b>1KIT.300.C</b>		<b>90,00</b>

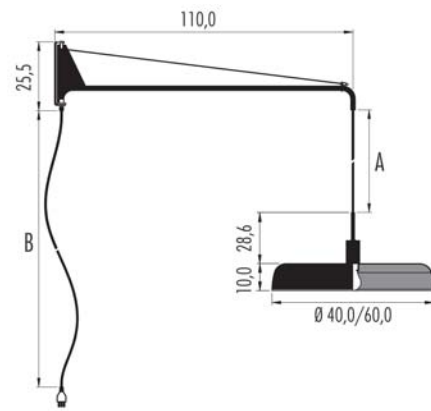
**MoMa L** bi-color

IP20	Ⓛ	A+B=300cm	CE	▽
220-240V	e27	4W CRI>80	dimmable IGBT - Triac	
<b>3M40L.12L.</b>	□	Ø 40cm	€ 1.100,00	
<b>3M60L.12L.</b>	□	Ø 60cm	€ 1.200,00	
Led color	Nominal lm	Beam spread		
2700K	470	163°		

□	Out	In	Diffuser - Diffusore	Frame - Struttura
KC	●	●	Black/Copper - Nero/Rame	Black - Nero
WC	○	●	White/Copper - Bianco/Rame	White - Bianco
BC	●	●	Blue/Copper - Blu/Rame	Blue - Blu
GC	●	●	Green/Copper - Verde/Rame	Green - Verde
PC	●	●	Rose/Copper - Rosa/Rame	Rose - Rosa
RC	●	●	Red/Copper - Rosso/Rame	Red - Rosso

Wire/Cavo  
Copper - Rame

Bulb/Lampadina  
Transparent - Trasparente

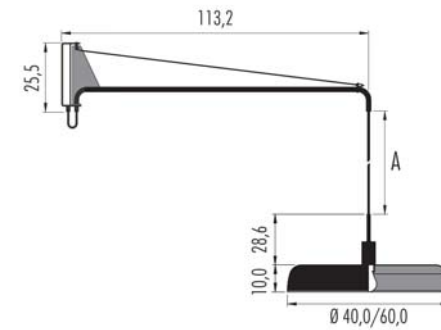
**MoMa M** bi-color

IP20	Ⓛ	A=130cm	CE	▽
220-240V	e27	4W CRI>80	dimmable IGBT - Triac	
<b>3M40M.12L.</b>	□	Ø 40cm	€ 1.100,00	
<b>3M60M.12L.</b>	□	Ø 60cm	€ 1.200,00	
Led color	Nominal lm	Beam spread		
2700K	470	163°		

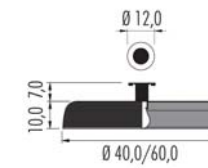
**MoMa W** bi-color  
ceiling - plafone

IP20	Ⓛ	CE	▽
220-240V	e27	4W CRI>80	dimmable IGBT - Triac
<b>3M40W.12L.</b>	□	Ø 40cm	€ 530,00
<b>3M60W.12L.</b>	□	Ø 60cm	€ 640,00
Led color	Nominal lm	Beam spread	
2700K	470	163°	

□	Out	In	Diffuser - Diffusore	Bulb - Lampadina
KC	●	●	Black/Copper - Nero/Rame	Transparent
WC	○	●	White/Copper - Bianco/Rame	Transparent
BC	●	●	Blue/Copper - Blu/Rame	Transparent
GC	●	●	Green/Copper - Verde/Rame	Transparent
PC	●	●	Rose/Copper - Rosa/Rame	Transparent
RC	●	●	Red/Copper - Rosso/Rame	Transparent

Bulb/Lampadina:  
Transparent - Trasparente

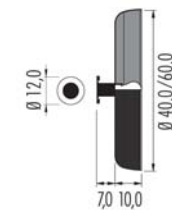
**MoMa P** bi-color  
wall/parete

IP20	Ⓛ	CE	▽
220-240V	e27	7W CRI>80	dimmable IGBT - Triac
<b>3M40P.12L.</b>	□	Ø 40cm	€ 530,00
<b>3M60P.12L.</b>	□	Ø 60cm	€ 640,00
Led color	Nominal lm	Beam spread	
2700K	806	163°	

□	Out	In	Diffuser - Diffusore	Bulb - Lampadina
KC	●	●	Black/Copper - Nero/Rame	●
WC	○	●	White/Copper - Bianco/Rame	●
BC	●	●	Blue/Copper - Blu/Rame	●
GC	●	●	Green/Copper - Verde/Rame	●
PC	●	●	Rose/Copper - Rosa/Rame	●
RC	●	●	Red/Copper - Rosso/Rame	●

Bulb/Lampadina:  
Mirror copper - Specchiata rame

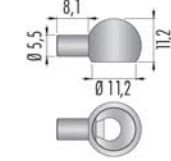
**Nelly**  
wall/parete

IP20	Ⓛ	CE	▽
220-240V	e27 4W	CRI>80	
<b>3N01.12L.</b>	□	dimm. IGBT - Triac	€ 310,00
Led color	Nominal lm	Beam spread	
2700K	470	40°	

□	Out	In	Diffuser - Diffusore
KC	●	●	Black/Copper - Nero/Rame
WC	○	●	White/Copper - Bianco/Rame
BC	●	●	Blue/Copper - Blu/Rame
GC	●	●	Green/Copper - Verde/Rame
PC	●	●	Rose/Copper - Rosa/Rame
RC	●	●	Red/Copper - Rosso/Rame

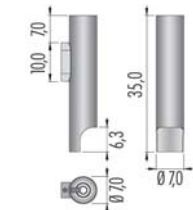
**Nemo**  
wall/parete

IP20	Flicker < 20%	CE	▽	MC-E=3
220-240V	9,5W CRI>90	dimm. IGBT - TRIAC		
<b>4N05.K2S.KC</b>	With honeycomb	€ 310,00		
<b>4N05.K2S.WC</b>	With honeycomb	€ 310,00		
<b>4N05.K2S.BC</b>	With honeycomb	€ 350,00		
<b>4N05.K2S.GC</b>	With honeycomb	€ 350,00		
<b>4N05.K2S.PC</b>	With honeycomb	€ 350,00		
<b>4N05.K2S.RC</b>	With honeycomb	€ 350,00		
Led color	Nominal lm	Beam spread		
2700K	710	24°		

□	Out	In	Diffuser - Diffusore
KC	●	●	Black/Copper - Nero/Rame
WC	○	●	White/Copper - Bianco/Rame
BC	●	●	Blue/Copper - Blu/Rame
GC	●	●	Green/Copper - Verde/Rame
PC	●	●	Rose/Copper - Rosa/Rame
RC	●	●	Red/Copper - Rosso/Rame



## Pop Bijou

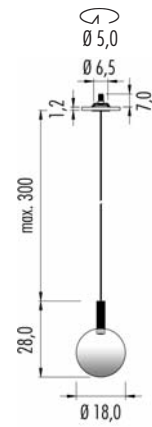

IP40	©	ARC	CE	▽
220-240V	6W	CRI>90	dimmable IGBT - Triac	
<b>3BUA.2</b>		■ S. □	€ 390,00	

Led color	Nominal lm	Beam spread
2 = 2700K	528	25°
3 = 3000K	552	

ARC canopy - rosone: White - Bianco

## Pop C'est Moi

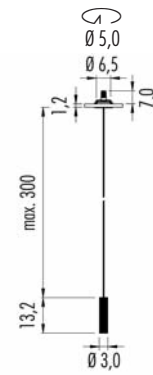

IP20	©	ARC	CE	▽
220-240V	6W	CRI>90	dimmable IGBT - Triac	
<b>3CMA.2</b>		■ S. □	€ 335,00	

Led color	Nominal lm	Beam spread
2 = 2700K	528	20°
3 = 3000K	552	

ARC canopy - rosone: White - Bianco

## Pop C'est Toi

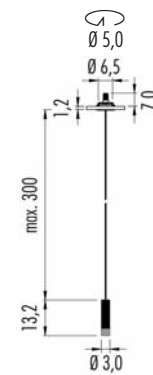

IP20	©	ARC	CE	▽
220-240V	6W	CRI>90	dimmable IGBT - Triac	
<b>3CTA.2</b>		■ S. □	€ 290,00	

Led color	Nominal lm	Beam spread
2 = 2700K	528	20°
3 = 3000K	552	

ARC canopy - rosone: White - Bianco

## Pop Chérie

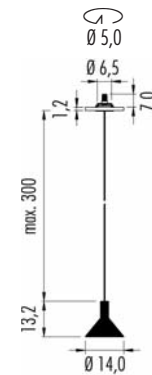

IP20	©	ARC	CE	▽
220-240V	6W	CRI>90	dimmable IGBT - Triac	
<b>3CEA.2</b>		■ S. □	€ 350,00	

Led color	Nominal lm	Beam spread
2 = 2700K	528	20°
3 = 3000K	552	

ARC canopy - rosone: White - Bianco

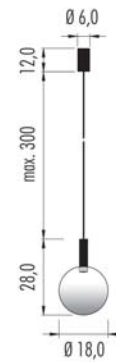

IP40	©	CUP	CE	▽
220-240V	6W	CRI>90	on/off	
<b>3BUC.2</b>		■ S. □	€ 400,00	

Led color	Nominal lm	Beam spread
2 = 2700K	528	25°
3 = 3000K	552	

CUP canopy - rosone: Black - Nero

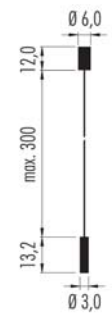

IP20	©	CUP	CE	▽
220-240V	6W	CRI>90	on/off	
<b>3CMC.2</b>		■ S. □	€ 345,00	

Led color	Nominal lm	Beam spread
2 = 2700K	528	20°
3 = 3000K	552	

look at table - vedi tabella

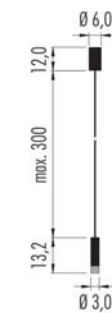

IP20	©	CUP	CE	▽
220-240V	6W	CRI>90	on/off	
<b>3CTC.2</b>		■ S. □	€ 300,00	

Led color	Nominal lm	Beam spread
2 = 2700K	528	20°
3 = 3000K	552	

CUP canopy - rosone: Black - Nero

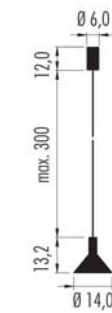

IP20	©	CUP	CE	▽
220-240V	6W	CRI>90	on/off	
<b>3CEC.2</b>		■ S. □	€ 360,00	

Led color	Nominal lm	Beam spread
2 = 2700K	528	20°
3 = 3000K	552	

look at table - vedi tabella

□	Cylinder - Cilindro
02 ●	Black - Nero
06 ○	White - Bianco
C1 ●	Copper Anodized - Rame anodizzato
S1 ●	Brass Anodized - Ottone anodizzato

Black power supply cable.  
Cavo di alimentazione, nero.

□	Frame - Struttura	CUP - Rosone
02 ●	Black - Nero	Black - Nero
06 ○	White - Bianco	White - Bianco

Black power supply cable.  
Cavo di alimentazione, nero.

□	Cylinder - Cilindro
02 ●	Black - Nero
06 ○	White - Bianco
C1 ●	Copper Anodized - Rame anodizzato
S1 ●	Brass Anodized - Ottone anodizzato

Black power supply cable.  
Cavo di alimentazione, nero.

□	Frame - Struttura	CUP - Rosone
02 ●	Black - Nero	Black - Nero
06 ○	White - Bianco	White - Bianco

Black power supply cable.  
Cavo di alimentazione, nero.

## Pop Chapeau

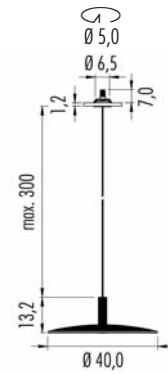

IP20	ARC	CE
220-240V	6W CRI>90	dimmiabile IGBT - Triac
<b>3CHA.2</b>	S. □	€ <b>350,00</b>
<b>Led color</b>	<b>Nominal lm</b>	<b>Beam spread</b>
2 = 2700K	528	20°
3 = 3000K	552	

ARC canopy - rosone: White - Bianco

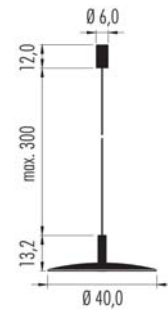

IP20	CUP	CE
220-240V	6W CRI>90	on/off
<b>3CHC.2</b>	S. □	€ <b>360,00</b>
<b>Led color</b>	<b>Nominal lm</b>	<b>Beam spread</b>
2 = 2700K	528	20°
3 = 3000K	552	

CUP canopy - rosone: Black - Nero

□ Up Down

02	●●	Black/Black - Nero/Nero
06	○○	White/White - Bianco/Bianco
C1K	●●	Copper Anodized/Black - Rame anodizzato/Nero
C1W	○○	Copper Anodized/White - Rame anodizzato/Bianco
S1K	●●	Brass Anodized/Black - Ottone anodizzato/Nero
S1W	○○	Brass Anodized/White - Ottone anodizzato/Bianco

Black power supply cable.  
Cavo di alimentazione, nero.

## Filo System: 500 m/A

## Pop Bijou



IP40	CE	CE
500 m/A	6W	CRI>90
<b>3BU1.2</b>	S. □ 12m Cable	€ <b>340,00</b>
<b>3BU2.2</b>	S. □ 22m Cable	€ <b>420,00</b>
<b>Led color</b>	<b>Nominal lm</b>	<b>Beam spread</b>
2 = 2700K	528	25°
3 = 3000K	552	

## Pop C'est Moi



IP20	CE	CE
500 m/A	6W	CRI>90
<b>3CM1.2</b>	S. □ 12m Cable	€ <b>250,00</b>
<b>3CM2.2</b>	S. □ 22m Cable	€ <b>300,00</b>
<b>Led color</b>	<b>Nominal lm</b>	<b>Beam spread</b>
2 = 2700K	528	20°
3 = 3000K	552	

## Pop C'est Toi



IP20	CE	CE
500 m/A	6W	CRI>90
<b>3CT1.2</b>	S. □ 12m Cable	€ <b>200,00</b>
<b>3CT2.2</b>	S. □ 22m Cable	€ <b>250,00</b>
<b>Led color</b>	<b>Nominal lm</b>	<b>Beam spread</b>
2 = 2700K	528	20°
3 = 3000K	552	

## Pop Chérie



IP40	CE	CE
500 m/A	6W	CRI>90
<b>3CE1.2</b>	S. □ 12m Cable	€ <b>290,00</b>
<b>3CE2.2</b>	S. □ 22m Cable	€ <b>340,00</b>
<b>Led color</b>	<b>Nominal lm</b>	<b>Beam spread</b>
2 = 2700K	528	20°
3 = 3000K	552	

## Pop Chapeau

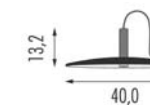

IP20	CE	CE
500 m/A	6W	CRI>90
<b>3CH1.2</b>	S. □ 12m Cable	€ <b>300,00</b>
<b>3CH2.2</b>	S. □ 22m Cable	€ <b>350,00</b>
<b>Led color</b>	<b>Nominal lm</b>	<b>Beam spread</b>
2 = 2700K	528	20°
3 = 3000K	552	



CUP Canopy	min. 3 max 12 diffusers	Black - Nero
<b>3FL5.029.02</b>	on/off	€ <b>460,00</b>
<b>3FL5.C29.02</b>	0/1...10V	€ <b>560,00</b>
<b>3FL5.F29.02</b>	DALI - Push	€ <b>560,00</b>



CUP Canopy	min. 6 max 24 diffusers	Black - Nero
<b>3FL5.033.02</b>	On/off	€ <b>750,00</b>
<b>3FL5.E33.02</b>	DALI - Push - 0/1...10V	€ <b>850,00</b>



CUP Canopy	for max 2 diffusers	Black - Nero
<b>3FL5.CUP.02</b>	IGBT - Triac	€ <b>285,00</b>



CUP with Plug-in	for max 1 diffuser	Black - Nero
<b>3FL5.PIN.02</b>	On/off	€ <b>280,00</b>

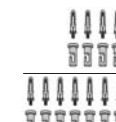

Mounting supports - Supporti di fissaggio Sistema Filo

<b>1KIT.WM5.02</b>	5 units Black	€ <b>22,00</b>
<b>1KIT.WM8.02</b>	8 units Black	€ <b>32,00</b>

## Pop Petit

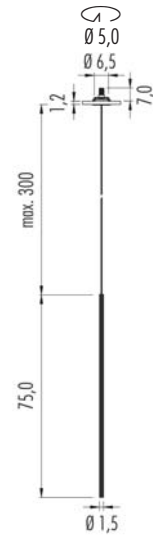

IP54	ARC	CE	▽
220-240V	2,3W CRI>90	on/off	
<b>3PTA.2</b>	<b>L.</b>	€ <b>350,00</b>	

Led color	Nominal lm	Beam spread
2 = 2700K	237	60°
3 = 3000K	256	

ARC canopy - rosone: White - Bianco

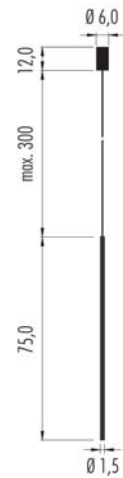

IP20	CUP	CE	▽
220-240V	2,3W CRI>90	on/off	
<b>3PTC.2</b>	<b>L.</b>	€ <b>360,00</b>	

Led color	Nominal lm	Beam spread
2 = 2700K	237	60°
3 = 3000K	256	

look at table - vedi tabella

□ Frame - Struttura CUP - Rosone

02	● Black - Nero	Black - Nero
06	○ White - Bianco	White - Bianco

Black power supply cable.  
Cavo di alimentazione, nero.

## Pop Petit - Filo System: 700 m/A

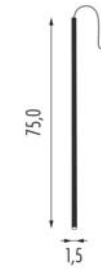

IP40		CE	▽
700 m/A	2,3W	CRI>90	
<b>3PT1.2</b>	<b>L.</b>	€ <b>300,00</b>	
<b>3PT2.2</b>	<b>L.</b>	€ <b>350,00</b>	

Led color	Nominal lm	Beam spread
2 = 2700K	528	60°
3 = 3000K	552	



CUP Canopy	min. 3 max 12 diffusers	Black - Nero
<b>3FL7.029.02</b>	on/off	€ <b>460,00</b>
<b>3FL7.F29.02</b>	DALI - Push	€ <b>600,00</b>



CUP Canopy	min. 6 max 24 diffusers	Black - Nero
<b>3FL7.033.02</b>	On/off	€ <b>750,00</b>

CUP Canopy	min. 3 max 24 diffusers	Black - Nero
<b>3FL7.E33.02</b>	DALI - Push - 0/1...10V	€ <b>850,00</b>



CUP Canopy	for max 2 diffusers	Black - Nero
<b>3FL7.CUP.02</b>	IGBT - Triac	€ <b>285,00</b>



CUP with Plug-in	for max 1 diffuser	Black - Nero
<b>3FL7.PIN.02</b>	On/off	€ <b>280,00</b>

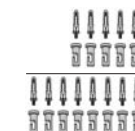

Mounting supports - Supporti di fissaggio Sistema Filo

<b>1KIT.WM5.02</b>	5 units Black	€ <b>22,00</b>
<b>1KIT.WM8.02</b>	8 units Black	€ <b>32,00</b>

## Pop Bon Bon

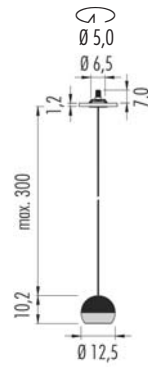

IP20	ARC	CE	∇
220-240V	8W CRI>95	on/off	
3BBA.2	02	€ 420,00	
3BBA.2	06	€ 420,00	
3BBA.2	BC	€ 460,00	
3BBA.2	GC	€ 460,00	
3BBA.2	PC	€ 460,00	
3BBA.2	CR	€ 460,00	
	<b>Led color</b>	<b>Nominal lm</b>	<b>Beam spread</b>
2	= 2700K	893	M = 38°
3	= 3000K	939	S = 22°

ARC canopy - rosone: White - Bianco

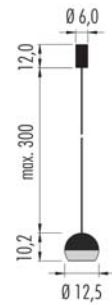

IP20	CUP	CE	∇
220-240V	8W CRI>95	on/off	
3BBC.2	02	€ 430,00	
3BBC.2	06	€ 430,00	
3BBC.2	BC	€ 470,00	
3BBC.2	GC	€ 470,00	
3BBC.2	PC	€ 470,00	
3BBC.2	CR	€ 470,00	
	<b>Led color</b>	<b>Nominal lm</b>	<b>Beam spread</b>
2	= 2700K	893	M = 38°
3	= 3000K	939	S = 22°

look at table - vedi tabella

□	Up	Down	CUP - Rosone
02	●	●	Black/Black - Nero/Nero Black - Nero
06	○	○	White/White - Bianco/Bianco White - Bianco
BC	●	●	Blue/Copper - Blu/Rame Black - Nero
GC	●	●	Green/Copper - Verde/Rame Black - Nero
PC	●	●	Rose/Copper - Rosa/Rame Black - Nero
CR	●	●	Copper/Red - Rame/Rosso Black - Nero

Black power supply cable.  
Cavo di alimentazione, nero.

## Pop Bon Bon - Filo System: 250 m/A



IP20	250 m/A	8W	CE	∇
			CRI>95	
3BB1.2	02	12m Cable	€ 350,00	
3BB1.2	06	12m Cable	€ 350,00	
3BB1.2	BC	12m Cable	€ 396,00	
3BB1.2	GC	12m Cable	€ 396,00	
3BB1.2	PC	12m Cable	€ 396,00	
3BB1.2	CR	12m Cable	€ 396,00	
3BB2.2	02	22m Cable	€ 436,00	
3BB2.2	06	22m Cable	€ 436,00	
3BB2.2	BC	22m Cable	€ 486,00	
3BB2.2	GC	22m Cable	€ 486,00	
3BB2.2	PC	22m Cable	€ 486,00	
3BB2.2	CR	22m Cable	€ 486,00	
	<b>Led color</b>	<b>Nominal lm</b>	<b>Beam spread</b>	
2	= 2700K	893	M = 38°	
3	= 3000K	939	S = 22°	



CUP Canopy	min. 3 max 3 diffusers	Black - Nero
3FL2.029.02	On/off	€ 460,00
3FL2.F29.02	DALI - Push	€ 600,00



CUP Canopy	min. 6 max 6 diffusers	Black - Nero
3FL2.033.02	On/off	€ 750,00

CUP Canopy	min. 3 max 9 diffusers	Black - Nero
3FL2.E33.02	DALI - Push - 0/1...10V	€ 850,00



CUP Canopy	for max 2 diffusers	Black - Nero
3FL2.CUP.02	On/off	€ 285,00



CUP with Plug-in	for max 1 diffuser	Black - Nero
3FL2.PIN.02	On/off	€ 280,00

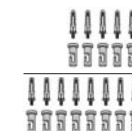

Mounting supports - Supporti di fissaggio Sistema Filo

1KIT.WM5.02	5 units Black	€ 22,00
1KIT.WM8.02	8 units Black	€ 32,00

**Pop 00** Ø 3,0 trimless

For plasterboard and brickwork. Per cartongesso e laterizio

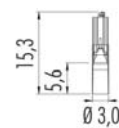

IP40	MC-E=3	CE	▽	⊕
500m/A	LED 6W	CRI>90		
<b>3P00.3</b>	<b>M.</b>	€	<b>135,00</b>	

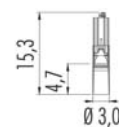

IP54	MC-E=3	CE	▽	⊕
500m/A	LED 6W	CRI>90		
<b>3P00.3</b>	<b>M9.</b>	€	<b>145,00</b>	
<b>Led color</b>	<b>Nominal lm</b>	<b>Beam spread</b>		
2 = 2700K	528	17°		
3 = 3000K	552			

© (m-M) driver ONLY in remote installation  
posizionare il driver in remoto

<b>3KIT.500.15</b> (1-1)	on/off	€	<b>30,00</b>
<b>3KIT.501.50</b> (1-7)	DALI - Push - 1...10V	€	<b>125,00</b>
<b>3KIT.502.20</b> (1-3)	DALI	€	<b>67,00</b>
<b>3KIT.503.20</b> (1-3)	Push - 1...10	€	<b>62,00</b>
<b>3KIT.504.10</b> (1-1)	IGBT - TRIAC	€	<b>32,00</b>

Pop P00: housing for plasterboard - Cassaforma cartongesso

- **1Z00.030.01** Ø 4,0cm € **30,00**

Pop P00: housing for brickwork - Cassaforma laterizio

- **1M00.030.01** € **75,00**

□ Frame - Struttura

02 ● Black - Nero

06 ○ White - Bianco

**Pop 00 NaNo** Ø 3,0 trimless

For plasterboard. Per cartongesso

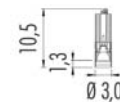

IP40	MC-E=3	CE	▽	⊕
500m/A	LED 6W	CRI>90		
<b>3N00.3</b>	<b>M.</b>	€	<b>95,00</b>	

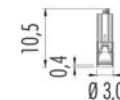

IP54	MC-E=3	CE	▽	⊕
500m/A	LED 6W	CRI>90		
<b>3N00.3</b>	<b>M9.</b>	€	<b>105,00</b>	
<b>Led color</b>	<b>Nominal lm</b>	<b>Beam spread</b>		
2 = 2700K	528	25°		
3 = 3000K	552			

© (m-M) driver ONLY in remote installation  
posizionare il driver in remoto

<b>3KIT.500.15</b> (1-1)	on/off	€	<b>30,00</b>
<b>3KIT.501.50</b> (1-7)	DALI - Push - 1...10V	€	<b>125,00</b>
<b>3KIT.502.20</b> (1-3)	DALI	€	<b>67,00</b>
<b>3KIT.503.20</b> (1-3)	Push - 1...10	€	<b>62,00</b>
<b>3KIT.504.10</b> (1-1)	IGBT - TRIAC	€	<b>32,00</b>

Pop N00 NaNo: housing for plasterboard - Cassaforma cartongesso

- **1N00.030.01** Ø 4,0cm € **30,00**

□ Frame - Struttura

02 ● Black - Nero

06 ○ White - Bianco

**easy Pop 00** Ø 3,0 with trim

For plasterboard and brickwork. Per cartongesso e laterizio

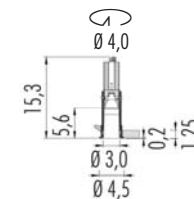

IP40	MC-E=3	CE	▽	⊕
500m/A	LED 6W	CRI>90		
<b>3E00.3</b>	<b>M.</b>	€	<b>145,00</b>	

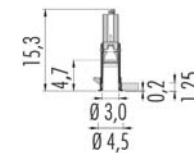

IP54	MC-E=3	CE	▽	⊕
500m/A	LED 6W	CRI>90		
<b>3E00.3</b>	<b>M9.</b>	€	<b>160,00</b>	
<b>Led color</b>	<b>Nominal lm</b>	<b>Beam spread</b>		
2 = 2700K	528	17°		
3 = 3000K	552			

© (m-M) driver ONLY in remote installation  
posizionare il driver in remoto

<b>3KIT.500.15</b> (1-1)	on/off	€	<b>30,00</b>
<b>3KIT.501.50</b> (1-7)	DALI - Push - 1...10V	€	<b>125,00</b>
<b>3KIT.502.20</b> (1-3)	DALI	€	<b>67,00</b>
<b>3KIT.503.20</b> (1-3)	Push - 1...10	€	<b>62,00</b>
<b>3KIT.504.10</b> (1-1)	IGBT - TRIAC	€	<b>32,00</b>

Housing for brickwork - Cassaforma laterizio

- **1E00.030.01** € **37,00**

□ Frame - Struttura

02 ● Black - Nero

06 ○ White - Bianco

**easy Pop 00 NaNo** Ø 3,0 with trim

For plasterboard and brickwork. Per cartongesso e laterizio

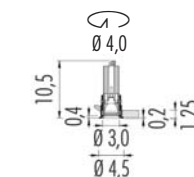

IP40	MC-E=3	CE	▽	⊕
500m/A	LED 6W	CRI>90		
<b>3F00.3</b>	<b>M.</b>	€	<b>120,00</b>	



IP54	MC-E=3	CE	▽	⊕
500m/A	LED 6W	CRI>90		
<b>3F00.3</b>	<b>M9.</b>	€	<b>130,00</b>	
<b>Led color</b>	<b>Nominal lm</b>	<b>Beam spread</b>		
2 = 2700K	528	25°		
3 = 3000K	552			

© (m-M) driver ONLY in remote installation  
posizionare il driver in remoto

<b>3KIT.500.15</b> (1-1)	on/off	€	<b>30,00</b>
<b>3KIT.501.50</b> (1-7)	DALI - Push - 1...10V	€	<b>125,00</b>
<b>3KIT.502.20</b> (1-3)	DALI	€	<b>67,00</b>
<b>3KIT.503.20</b> (1-3)	Push - 1...10	€	<b>62,00</b>
<b>3KIT.504.10</b> (1-1)	IGBT - TRIAC	€	<b>32,00</b>

Housing for brickwork - Cassaforma laterizio

- **1E00.030.01** € **37,00**

□ Frame - Struttura

02 ● Black - Nero

06 ○ White - Bianco

**Pop 01** Ø 4,0 trimless

For plasterboard. Per cartongesso

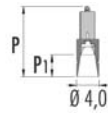

Pop P01	P	P1
3P01.200.□	led IP40 9,1	3,9
3P01.2.■ S.□	led IP40 13,2	3,9
3P01.2.■ S9.□	led IP54 14,0	3,9

IP40	Ⓢ	Ⓢ	CE	∇	⚡
12V					
<b>3P01.200.□</b>		<b>GU4</b> max 35W	€	<b>40,00</b>	
<b>3KIT.201.050</b>		max 50VA	€	<b>35,00</b>	
<i>Dimmable gear: IGBT</i>					

IP40	Ⓢ	MC-E=3	CE	∇	⚡
500m/A		<b>LED 6W</b>	CRI>90		
<b>3P01.2.■ S.□</b>			€	<b>120,00</b>	
<b>IP54</b>	Ⓢ	MC-E=3	CE	∇	⚡
500m/A		<b>LED 6W</b>	CRI>90		
<b>3P01.2.■ S9.□</b>			€	<b>150,00</b>	

■ Led color	Nominal lm	▲ Beam spread
2 = 2700K	528	22°
3 = 3000K	552	

Ⓢ (m-M)	Driver	
<b>3KIT.500.15</b> (1-1)	on/off	€ <b>30,00</b>
<b>3KIT.501.50</b> (1-7)	DALI - Push - 1...10V <i>remote installation - in remoto</i>	€ <b>125,00</b>
<b>3KIT.502.20</b> (1-3)	DALI <i>remote installation - in remoto</i>	€ <b>67,00</b>
<b>3KIT.503.20</b> (1-3)	Push - 1...10 <i>remote installation - in remoto</i>	€ <b>62,00</b>
<b>3KIT.504.10</b> (1-1)	IGBT - TRIAC <i>remote installation - in remoto</i>	€ <b>32,00</b>

Housing for plasterboard - Cassaforma cartongesso

- **1Z00.040.01** Ⓢ Ø 5,1cm € **30,00**

□ **Frame - Struttura**

- 02 ● Black - Nero
- 06 ○ White - Bianco

*(m-M) = min. Led unit - Max Led unit. Led and Emergency unit, warranty only when used together with driver bought from Oty srl.***easy Pop 01** Ø 4,0 with trim

For plasterboard and brickwork. Per cartongesso e laterizio

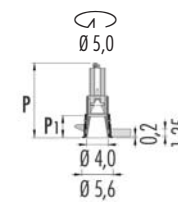

Pop E01	P	P1
3E01.200.□	led IP40 9,1	3,9
3E01.2.■ S.□	led IP40 13,2	3,9
3E01.2.■ S9.□	led IP54 14,0	3,9

IP40	Ⓢ	Ⓢ	CE	∇	⚡
12V					
<b>3E01.200.□</b>		<b>GU4</b> max 35W	€	<b>75,00</b>	
<b>3KIT.201.050</b>		max 50VA	€	<b>35,00</b>	
<i>Dimmable gear: IGBT</i>					

IP40	Ⓢ	MC-E=3	CE	∇	⚡
500m/A		<b>LED 6W</b>	CRI>90		
<b>3E01.2.■ S.□</b>			€	<b>140,00</b>	
<b>IP54</b>	Ⓢ	MC-E=3	CE	∇	⚡
500m/A		<b>LED 6W</b>	CRI>90		
<b>3E01.2.■ S9.□</b>			€	<b>165,00</b>	

■ Led color	Nominal lm	▲ Beam spread
2 = 2700K	528	22°
3 = 3000K	552	

Ⓢ (m-M)	Driver	
<b>3KIT.500.15</b> (1-1)	on/off	€ <b>30,00</b>
<b>3KIT.501.50</b> (1-7)	DALI - Push - 1...10V <i>remote installation - in remoto</i>	€ <b>125,00</b>
<b>3KIT.502.20</b> (1-3)	DALI <i>remote installation - in remoto</i>	€ <b>67,00</b>
<b>3KIT.503.20</b> (1-3)	Push - 1...10 <i>remote installation - in remoto</i>	€ <b>62,00</b>
<b>3KIT.504.10</b> (1-1)	IGBT - TRIAC <i>remote installation - in remoto</i>	€ <b>32,00</b>

Housing for brickwork - Cassaforma laterizio

- **1E00.040.01** € **39,00**

□ **Frame - Struttura**

- 02 ● Black - Nero
- 06 ○ White - Bianco

*(m-M) = gestione minima e massima delle unità Led. I Led e le unità di emergenza, sono coperti da garanzia solo se utilizzati in abbinamento con i driver forniti dalla Oty srl.*







**Pop 01 small Bulb** *trimless*

For plasterboard and brickwork. Per cartongesso e laterizio

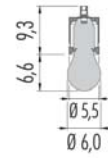

IP20	CE	V	□
220V ÷ 240V	e27 led 4W	CRI>80	
<b>3P01.A2L.□</b>	dimmi IGBT - TRIAC	€ 85,00	
■ Led color	Nominal lm	▲ Beam spread	
2700K	470	360°	

Housing for plasterboard - Cassaforma cartongesso ↻ Ø 6,5cm

- 1Z00.055.01 Single € 30,00
- 1Z00.055.2L Double € 50,00
- 1Z00.055.3L Triple € 80,00

Housing for brickwork - Cassaforma laterizio

- 1M00.055.01 € 100,00

**Pop 01 big Bulb** *trimless*

For plasterboard and brickwork. Per cartongesso e laterizio

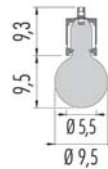

IP20	CE	V	□
220V ÷ 240V	e27 led 4W	CRI>80	
<b>3P01.B2L.□</b>	dimmi IGBT - TRIAC	€ 90,00	
■ Led color	Nominal lm	▲ Beam spread	
2700K	470	360°	

Housing for plasterboard - Cassaforma cartongesso ↻ Ø 6,5cm

- 1Z00.055.01 € 30,00

Housing for brickwork - Cassaforma laterizio

- 1M00.055.01 € 100,00

□ Frame - Struttura

02 ● Black - Nero

06 ○ White - Bianco

**easy Pop 01 small Bulb** *with trim*

For plasterboard and brickwork. Per cartongesso e laterizio

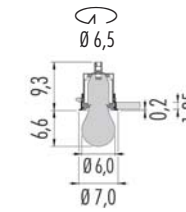

IP20	CE	V	□
220V ÷ 240V	e27 led 4W	CRI>80	
<b>3E01.A2L.□</b>	dimmi IGBT - TRIAC	€ 110,00	
■ Led color	Nominal lm	▲ Beam spread	
2700K	470	360°	

**easy Pop 01 big Bulb** *with trim*

For plasterboard and brickwork. Per cartongesso e laterizio

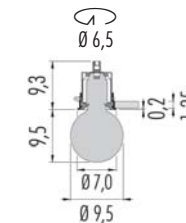

IP20	CE	V	□
220V ÷ 240V	e27 led 4W	CRI>80	
<b>3E01.B2L.□</b>	dimmi IGBT - TRIAC	€ 120,00	
■ Led color	Nominal lm	▲ Beam spread	
2700K	470	360°	

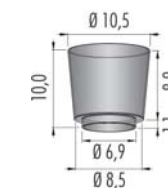

Housing for brickwork - Cassaforma laterizio

- 1E00.055.01 € 39,00

□ Frame - Struttura

02 ● Black - Nero



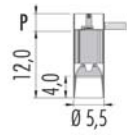

06 ○ White - Bianco

### Pop 02 Ø 5,5 trimless

For plasterboard and brickwork. Per cartongesso e laterizio



IP20 	CE	V	□
220V ÷ 240V			
<b>3P02.210.□</b>	<b>GU10</b> max 50W	€	<b>90,00</b>
<b>3P02.211.□</b>	<b>GU10</b> led	€	<b>90,00</b>
<b>4P02.211.□</b>	<b>GU10</b> led	€	<b>100,00</b>
<i>With honeycomb. Con frangiluce</i>			

Pop P02	P
3P02.210.□ GU10	4,7
3P02.211.□ GU10 led	—
4P02.211.□ GU10 led + honeycomb	—
3P02.220.□ GU5.3	4,7
4P02.220.□ GU5.3 led + honeycomb	—
3P02.3  .□ led IP40	4,7
4P02.3  .□ led IP40 + honeycomb	4,7
3P02.3W  .□ led IP40	4,7
4P02.3W  .□ led IP40 + honeycomb	4,7

□ Frame - Struttura

- 02 ● Black - Nero  
06 ○ White - Bianco

IP20 	CE	V	□	⊕
12V				
<b>3P02.220.□</b>	<b>GU5.3</b> max 50W	€	<b>90,00</b>	
<b>4P02.220.□</b>	<b>GU5.3</b> led	€	<b>100,00</b>	
<i>With honeycomb. Con frangiluce</i>				
<b>3KIT.201.050</b>	max 50VA	€	<b>35,00</b>	
<i>Dimmable gear: IGBT</i>				
IP40 	MC-E=3	CE	V	⊕
350m/A	<b>LED 11W</b>	CRI>95		
<b>3P02.3 .□</b>		€	<b>120,00</b>	
<b>4P02.3 .□</b>		€	<b>130,00</b>	
<i>With honeycomb. Con frangiluce</i>				

Led color	Nominal lm	Beam spread
2 = 2700K	1195	S = 22°
3 = 3000K	1257	T = 12°
4 = 4000K	1313	

© (m-M)	Driver	€
<b>3KIT.350.1L</b> (1-1)	on/off	€ <b>21,00</b>
<b>3KIT.351.40</b> (1-3)	DALI - Push - 1...10V <i>remote installation - in remoto</i>	€ <b>125,00</b>
<b>3KIT.352.15</b> (1-1)	DALI	€ <b>67,00</b>
<b>3KIT.353.15</b> (1-1)	Push - 1...10V	€ <b>62,00</b>
<b>3KIT.354.18</b> (1-1)	IGBT - TRIAC	€ <b>32,00</b>

Housing for plasterboard - Cassaforma cartongesso  Ø 6,5cm

- **1Z00.055.01** Single € **30,00**
- **1Z00.055.2L** Double € **50,00**
- **1Z00.055.3L** Triple € **80,00**

Housing for brickwork - Cassaforma laterizio

- **1M00.055.01** € **100,00**



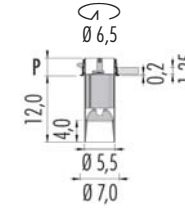

(m-M) = min. Led unit - Max Led unit. Led and Emergency unit, warranty only when used together with driver bought from Oty srl.

### easy Pop 02 Ø 5,5 with trim

For plasterboard and brickwork. Per cartongesso e laterizio



IP20 	CE	V	□
220V ÷ 240V			
<b>3E02.210.□</b>	<b>GU10</b> max 50W	€	<b>100,00</b>
<b>3E02.211.□</b>	<b>GU10</b> led	€	<b>100,00</b>
<b>4E02.211.□</b>	<b>GU10</b> led	€	<b>110,00</b>
<i>With honeycomb. Con frangiluce</i>			

easy Pop E02	P
3E02.210.□ GU10	4,7
3E02.211.□ GU10 led	—
4E02.211.□ GU10 led + honeycomb	—
3E02.220.□ GU5.3	4,7
4E02.220.□ GU5.3 led + honeycomb	—
3E02.3  .□ led IP40	4,7
4E02.3  .□ led IP40 + honeycomb	4,7
3E02.3W  .□ led IP40	4,7
4E02.3W  .□ led IP40 + honeycomb	4,7



□ Frame - Struttura

- 02 ● Black - Nero  
06 ○ White - Bianco

IP20 	CE	V	□	⊕
12V				
<b>3E02.220.□</b>	<b>GU5.3</b> max 50W	€	<b>100,00</b>	
<b>4E02.220.□</b>	<b>GU5.3</b> led	€	<b>110,00</b>	
<i>With honeycomb. Con frangiluce</i>				
<b>3KIT.201.050</b>	max 50VA	€	<b>35,00</b>	
<i>Dimmable gear: IGBT</i>				
IP40 	MC-E=3	CE	V	⊕
350m/A	<b>LED 11W</b>	CRI>95		
<b>3E02.3 .□</b>		€	<b>130,00</b>	
<b>4E02.3 .□</b>		€	<b>140,00</b>	
<i>With honeycomb. Con frangiluce</i>				

Led color	Nominal lm	Beam spread
2 = 2700K	1195	S = 22°
3 = 3000K	1257	T = 12°
4 = 4000K	1313	

© (m-M)	Driver	€
<b>3KIT.350.1L</b> (1-1)	on/off	€ <b>21,00</b>
<b>3KIT.351.40</b> (1-3)	DALI - Push - 1...10V <i>remote installation - in remoto</i>	€ <b>125,00</b>
<b>3KIT.352.15</b> (1-1)	DALI	€ <b>67,00</b>
<b>3KIT.353.15</b> (1-1)	Push - 1...10V	€ <b>62,00</b>
<b>3KIT.354.18</b> (1-1)	IGBT - TRIAC	€ <b>32,00</b>

IP40 	DimToWarm	CE	V	⊕
350m/A	LED 6W	CRI 95		
<b>3E02.3W .□</b>		€	<b>160,00</b>	
<b>4E02.3W .□</b>		€	<b>170,00</b>	
<i>With honeycomb. Con frangiluce</i>				

Led color	Nominal lm	Beam spread
W= max 3000K min. 1800K	max 445 lm min. 10 lm	M = 30° S = 18°

© (m-M)	Driver	€
<b>3KIT.352.W15</b> (1-1)	DALI	€ <b>67,00</b>
<b>3KIT.354.W10</b> (1-1)	IGBT - TRIAC	€ <b>30,00</b>

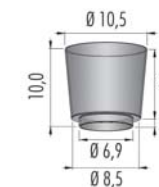

Housing for brickwork - Cassaforma laterizio

- **1E00.055.01** € **39,00**

(m-M) = gestione minima e massima delle unità Led. I Led e le unità di emergenza, sono coperti da garanzia solo se utilizzati in abbinamento con i driver forniti dalla Oty srl.

### Pop 03 Ø 6,0 trimless

For plasterboard. Per cartongesso

	IP20	CE	V	⊕
	12V			
<b>3P03.200</b> □	<b>GU4</b> max 35W	€	<b>70,00</b>	
<b>3KIT.201.050</b>	max 50VA	€	<b>35,00</b>	
Dimmable gear: IGBT				

	IP40	CE	V	⊕
	350m/A			
<b>3P03.2</b> ■ S. □	<b>LED 11W</b>	CRI>95		
■ Led color	Nominal lm	▲ Beam spread		
2 = 2700K	1195	22°		
3 = 3000K	1257			
4 = 4000K	1313			

© (m-M)	Driver		€
<b>3KIT.350.1L</b> (1-1)	on/off		<b>21,00</b>
<b>3KIT.351.40</b> (1-3)	DALI - Push - 1...10V	remote installation - in remoto	<b>125,00</b>
<b>3KIT.352.15</b> (1-1)	DALI		<b>67,00</b>
<b>3KIT.353.15</b> (1-1)	Push - 1...10V		<b>62,00</b>
<b>3KIT.354.18</b> (1-1)	IGBT - TRIAC		<b>32,00</b>

Emergency unit: (inverter + battery. Driver not included)  
remote installation - in remoto

<b>3KIT.900.01</b> (1-1)	1:00 hour	€	<b>110,00</b>
<b>3KIT.900.03</b> (1-1)	3:00 hours	€	<b>145,00</b>

Housing for plasterboard - Cassaforma cartongesso Ø 7,6cm

● <b>1Z00.060.01</b>	€	<b>45,00</b>
----------------------	---	--------------

□	Frame - Struttura
02 ●	Black - Nero
06 ○	White - Bianco

(m-M) = min. Led unit - Max Led unit. Led and Emergency unit, warranty only when used together with driver bought from Oty srl.

### Pop 03 NaNo Ø 6,0 trimless

For plasterboard. Per cartongesso

	IP40	CE	V	⊕
	250m/A			
<b>3N03.2</b> ■ S. □	<b>LED 8W</b>	CRI>95		
■ Led color	Nominal lm	▲ Beam spread		
2 = 2700K	779	22°		
3 = 3000K	819			
4 = 4000K	855			

© (m-M)	Driver		€
<b>3KIT.250.1L</b> (1-1)	on/off		<b>21,00</b>
<b>3KIT.251.28</b> (1-3)	DALI - Push - 1...10V	remote installation - in remoto	<b>125,00</b>
<b>3KIT.252.12</b> (1-1)	DALI		<b>67,00</b>
<b>3KIT.253.13</b> (1-1)	Push - 1...10V		<b>62,00</b>
<b>3KIT.254.12</b> (1-1)	IGBT - TRIAC		<b>32,00</b>

Emergency unit: (inverter + battery. Driver not included)  
remote installation - in remoto

<b>3KIT.900.01</b> (1-1)	1:00 hour	€	<b>110,00</b>
<b>3KIT.900.03</b> (1-1)	3:00 hours	€	<b>145,00</b>

Housing for plasterboard - Cassaforma cartongesso Ø 7,6cm

● <b>1Z00.060.01</b>	€	<b>45,00</b>
----------------------	---	--------------

□	Frame - Struttura
02 ●	Black - Nero
06 ○	White - Bianco

(m-M) = gestione minima e massima delle unità Led. I Led e le unità di emergenza, sono coperti da garanzia solo se utilizzati in abbinamento con i driver forniti dalla Oty srl.

## Pop 03 Ø 8,0 trimless

For plasterboard and brickwork. Per cartongesso e laterizio

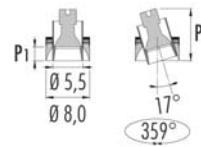

IP20	CE	V	□
220V ÷ 240V			
<b>3P03.210.</b> □	<b>GU10</b> max 50W	€	<b>95,00</b>
<b>3P03.211.</b> □	<b>GU10</b> led	€	<b>95,00</b>
<b>4P03.211.</b> □	<b>GU10</b> led	€	<b>105,00</b>
<i>With honeycomb. Con frangiluce</i>			

IP20	CE	V	⊕
12V			
<b>3P03.220.</b> □	<b>GU5.3</b> max 50W	€	<b>95,00</b>
<b>4P03.220.</b> □	<b>GU5.3</b> led	€	<b>105,00</b>
<i>With honeycomb. Con frangiluce</i>			
<b>3KIT.201.050</b>	max 50VA	€	<b>35,00</b>
<i>Dimmable gear: IGBT</i>			

IP40	Flicker < 20%	CE	V	⊕
220V ÷ 240V	<b>LED 9,5W</b>			
<b>3P03.K</b> □	dimmi IGBT - TRIAC	€	<b>120,00</b>	
<b>4P03.K</b> □	dimmi IGBT - TRIAC	€	<b>130,00</b>	
<i>With honeycomb. Con frangiluce</i>				
<b>Led color</b>	<b>Nominal lm</b>	<b>Beam spread</b>		
<b>2 = 2700K</b>	<b>710</b>	<b>M = 36°</b>		
<b>3 = 3000K</b>	<b>760</b>	<b>S = 24°</b>		

Housing for plasterboard - Cassaforma cartongesso ↻ Ø 9,5cm

- **1Z00.080.01** Single € **55,00**
- **1Z00.080.2L** Double € **110,00**
- **1Z00.080.3L** Triple € **150,00**

Housing for brickwork - Cassaforma laterizio

- **1M00.080.01** € **125,00**

□ **Frame - Struttura**02 ● **Black - Nero**06 ○ **White - Bianco**

(m-M) = min. Led unit - Max Led unit. Led and Emergency unit, warranty only when used together with driver bought from Oty srl.



IP40	MC-E=3	CE	V	⊕
350m/A	<b>LED 11W</b>			
<b>3P03.3</b> □		€	<b>135,00</b>	
<b>4P03.3</b> □		€	<b>145,00</b>	
<i>With honeycomb. Con frangiluce</i>				

Led color	Nominal lm	Beam spread
<b>2 = 2700K</b>	<b>1195</b>	<b>M = 38°</b>
<b>3 = 3000K</b>	<b>1257</b>	<b>S = 22°</b>
<b>4 = 4000K</b>	<b>1313</b>	<b>T = 10°</b>

© (m-M) Driver		€	
<b>3KIT.350.1L</b> (1-1)	on/off	€	<b>21,00</b>
<b>3KIT.351.40</b> (1-3)	DALI - Push - 1...10V remote installation - in remoto	€	<b>125,00</b>

<b>3KIT.352.15</b> (1-1)	DALI	€	<b>67,00</b>
<b>3KIT.353.15</b> (1-1)	Push - 1...10V	€	<b>62,00</b>
<b>3KIT.354.18</b> (1-1)	IGBT - TRIAC	€	<b>32,00</b>

Emergency unit: (inverter + battery. Driver not included)

<b>3KIT.900.01</b> (1-1)	1:00 hour	€	<b>110,00</b>
<b>3KIT.900.03</b> (1-1)	3:00 hours	€	<b>145,00</b>

IP40	DimToWarm	CE	V	⊕
350m/A	<b>LED 6W</b>			
<b>3P03.3W</b> □		€	<b>135,00</b>	
<b>4P03.3W</b> □		€	<b>145,00</b>	
<i>With honeycomb. Con frangiluce</i>				

Led color	Nominal lm	Beam spread
<b>W= max 3000K</b>	<b>max 445 lm</b>	<b>M = 30°</b>
<b>min. 1800K</b>	<b>min. 10 lm</b>	<b>S = 18°</b>

© (m-M) Driver		€	
<b>3KIT.352.W15</b> (1-1)	DALI	€	<b>67,00</b>
<b>3KIT.354.W10</b> (1-1)	IGBT - TRIAC	€	<b>30,00</b>

□

02 ●

06 ○

(m-M) = min. Led unit - Max Led unit. Led and Emergency unit, warranty only when used together with driver bought from Oty srl.

## Pop 03 NaNo Ø 8,0 trimless

For plasterboard and brickwork. Per cartongesso e laterizio

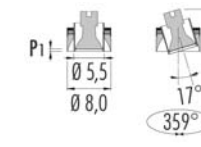

IP20	CE	V	□
220V ÷ 240V			
<b>3N03.210.</b> □	<b>GU10</b> max 50W	€	<b>95,00</b>
<b>3N03.211.</b> □	<b>GU10</b> led	€	<b>95,00</b>
<b>4N03.211.</b> □	<b>GU10</b> led	€	<b>105,00</b>
<i>With honeycomb. Con frangiluce</i>			

IP20	CE	V	⊕
12V			
<b>3N03.220.</b> □	<b>GU5.3</b> max 50W	€	<b>95,00</b>
<b>4N03.220.</b> □	<b>GU5.3</b> led	€	<b>105,00</b>
<i>With honeycomb. Con frangiluce</i>			
<b>3KIT.201.050</b>	max 50VA	€	<b>35,00</b>
<i>Dimmable gear: IGBT</i>			

IP40	Flicker < 20%	CE	V	⊕
220V ÷ 240V	<b>LED 9,5W</b>			
<b>3N03.K</b> □	dimmi IGBT - TRIAC	€	<b>120,00</b>	
<b>4N03.K</b> □	dimmi IGBT - TRIAC	€	<b>130,00</b>	
<i>With honeycomb. Con frangiluce</i>				
<b>Led color</b>	<b>Nominal lm</b>	<b>Beam spread</b>		
<b>2 = 2700K</b>	<b>710</b>	<b>M = 36°</b>		
<b>3 = 3000K</b>	<b>760</b>	<b>S = 24°</b>		

Housing for plasterboard - Cassaforma cartongesso ↻ Ø 9,5cm

- **1Z00.080.01** Single € **55,00**
- **1Z00.080.2L** Double € **110,00**
- **1Z00.080.3L** Triple € **150,00**

Housing for brickwork - Cassaforma laterizio

- **1M00.080.01** € **125,00**

□ **Frame - Struttura**02 ● **Black - Nero**06 ○ **White - Bianco**

(m-M) = gestione minima e massima delle unità Led. I Led e le unità di emergenza, sono coperti da garanzia solo se utilizzati in abbinamento con i driver forniti dalla Oty srl.

## easy Pop 03 Ø 8,0 with trim

For plasterboard and brickwork. Per cartongesso e laterizio

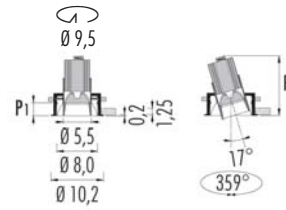

IP40	Flicker <20%	CE	▽	□
220V ÷ 240V	<b>LED 9,5W</b>	CRI>90		
<b>3E03.K</b> □	dimmi IGBT - TRIAC	€ 195,00		
<b>4E03.K</b> □	dimmi IGBT - TRIAC	€ 205,00		
With honeycomb. Con frangiluce				

Led color	Nominal lm	Beam spread
2 = 2700K	710	M = 36°
3 = 3000K	760	S = 24°

easy Pop E03	P	P1
3E03.K □ led 9,5W IP40	11,4	2,5
4E03.K □ led 9,5W IP40 + honeycomb	11,9	2,5
3E03.3 □ M □ led IP40	9,0	0,5
3E03.3 □ S □ led IP40	11,0	2,5
3E03.3 □ T □ led IP40	9,0	0,5
4E03.3 □ M □ led IP40 + honeycomb	9,5	0,5
4E03.3 □ S □ led IP40 + honeycomb	11,5	2,5
4E03.3 □ T □ led IP40 + honeycomb	9,5	0,5
3E03.3WM □ led IP40	6,8	0,5
3E03.3WS □ led IP40	8,8	2,5
4E03.3WM □ led IP40 + honeycomb	7,3	0,5
4E03.3WS □ led IP40 + honeycomb	9,3	2,5

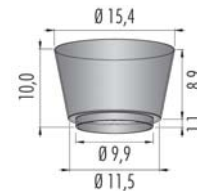

Housing for brickwork - Cassafornia laterizio

1E00.080.01 € 50,00

□ Frame - Struttura

- 02 ● Black - Nero  
06 ○ White - Bianco

(m-M) = min. Led unit - Max Led unit. Led and Emergency unit, warranty only when used together with driver bought from Oty srl.

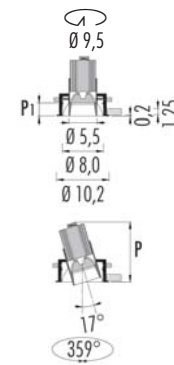

IP40	MC-E=3	CE	▽	⊕
350m/A	<b>LED 11W</b>	CRI>95		
<b>3E03.3</b> □		€ 195,00		
<b>4E03.3</b> □		€ 205,00		
With honeycomb. Con frangiluce				

Led color	Nominal lm	Beam spread
2 = 2700K	1195	M = 38°
3 = 3000K	1257	S = 22°
4 = 4000K	1313	T = 10°

© (m-M) Driver		
<b>3KIT.350.1L</b> (1-1)	on/off	€ 21,00
<b>3KIT.351.40</b> (1-3)	DALI - Push - 1...10V remote installation - in remoto	€ 125,00
<b>3KIT.352.15</b> (1-1)	DALI	€ 67,00
<b>3KIT.353.15</b> (1-1)	Push - 1...10V	€ 62,00
<b>3KIT.354.18</b> (1-1)	IGBT - TRIAC	€ 32,00

Emergency unit: (inverter + battery. Driver not included)

<b>3KIT.900.01</b> (1-1)	1:00 hour	€ 110,00
<b>3KIT.900.03</b> (1-1)	3:00 hours	€ 145,00

IP40	DimToWarm	CE	▽	⊕
350m/A	LED 6W	CRI 95		
<b>3E03.3W</b> □		€ 205,00		
<b>4E03.3W</b> □		€ 215,00		
With honeycomb				

Led color	Nominal lm	Beam spread
W= max 3000K min. 1800K	max 445 lm min. 10 lm	M = 30° S = 18°

© (m-M) Driver		
<b>3KIT.352.W15</b> (1-1)	DALI	€ 67,00
<b>3KIT.354.W10</b> (1-1)	IGBT - TRIAC	€ 30,00

## easy Pop 03 NaNo Ø 8,0 with trim

For plasterboard and brickwork. Per cartongesso e laterizio

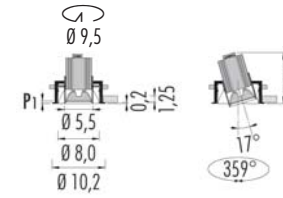

IP40	Flicker <20%	CE	▽	□
220V ÷ 240V	<b>LED 9,5W</b>	CRI>90		
<b>3F03.K</b> □	dimmi IGBT - TRIAC	€ 195,00		
<b>4F03.K</b> □	dimmi IGBT - TRIAC	€ 205,00		
With honeycomb. Con frangiluce				

Led color	Nominal lm	Beam spread
2 = 2700K	710	M = 36°
3 = 3000K	760	S = 24°

easy NaNo Pop F03	P	P1
3F03.K □ led 9,5W IP40	9,5	0,5
4F03.K □ led 9,5W IP40 + honeycomb	9,9	0,5
3F03.3 □ M □ led IP40	6,1	0,5
3F03.3 □ S □ led IP40	6,1	0,5
3F03.3 □ T □ led IP40	6,1	0,5
4F03.3 □ M □ led IP40 + honeycomb	6,6	0,5
4F03.3 □ S □ led IP40 + honeycomb	6,6	0,5
4F03.3 □ T □ led IP40 + honeycomb	6,6	0,5

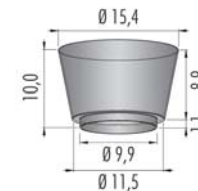

Housing for brickwork - Cassafornia laterizio

1E00.080.01 € 50,00

□ Frame - Struttura

- 02 ● Black - Nero  
06 ○ White - Bianco

(m-M) = gestione minima e massima delle unità Led. I Led e le unità di emergenza, sono coperti da garanzia solo se utilizzati in abbinamento con i driver forniti dalla Oty srl.

**Pop X3** Ø 10,0 trimless

For plasterboard. Per cartongesso

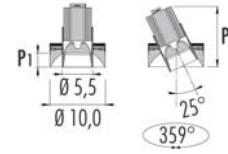

IP40	Flicker < 20%	CE	▽	□
220V ÷ 240V	<b>LED 9,5W</b>	CRI>90		
<b>3PX3.K</b>	dimmi IGBT - TRIAC	€ 155,00		
<b>4PX3.K</b>	dimmi IGBT - TRIAC	€ 165,00		
<i>With honeycomb. Con frangiluce</i>				

Led color	Nominal lm	Beam spread
2 = 2700K	710	M = 36°
3 = 3000K	760	S = 24°

Pop PX3	P	P1
3PX3.K	11,4	2,5
4PX3.K	11,9	2,5
3PX3.3  M. □	9,0	0,5
3PX3.3  S. □	11,0	2,5
3PX3.3  T. □	9,0	0,5
4PX3.3  M. □	9,5	0,5
4PX3.3  S. □	11,5	2,5
4PX3.3  T. □	9,5	0,5
3PX3.3WM. □	6,8	0,5
3PX3.3WS. □	8,8	2,5
4PX3.3WM. □	7,3	0,5
4PX3.3WS. □	9,3	2,5

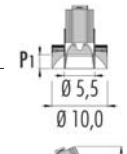

IP40	MC-E=3	CE	▽	⊕
350m/A	<b>LED 11W</b>	CRI>95		
<b>3PX3.3</b>		€ 155,00		
<b>4PX3.3</b>		€ 165,00		
<i>With honeycomb. Con frangiluce</i>				

Led color	Nominal lm	Beam spread
2 = 2700K	1195	M = 38°
3 = 3000K	1257	S = 22°
4 = 4000K	1313	T = 10°

© (m-M) Driver		
<b>3KIT.350.1L</b> (1-1)	on/off	€ 21,00
<b>3KIT.351.40</b> (1-3)	DALI - Push - 1...10V <i>remote installation - in remoto</i>	€ 125,00
<b>3KIT.352.15</b> (1-1)	DALI	€ 67,00
<b>3KIT.353.15</b> (1-1)	Push - 1...10V	€ 62,00
<b>3KIT.354.18</b> (1-1)	IGBT - TRIAC	€ 32,00

Emergency unit: (inverter + battery. Driver not included)

<b>3KIT.900.01</b> (1-1)	1:00 hour	€ 110,00
<b>3KIT.900.03</b> (1-1)	3:00 hours	€ 145,00

Housing for plasterboard - Cassaforma cartongesso Ø 11,4cm

- **1Z00.100.01** € 55,00

□ **Frame - Struttura**

- 02 ● Black - Nero
- 06 ○ White - Bianco

IP40	DimToWarm	CE	▽	⊕
350m/A	LED 6W	CRI 95		
<b>3PX3.3W</b>		€ 170,00		
<b>4PX3.3W</b>		€ 180,00		
<i>With honeycomb. Con frangiluce</i>				

Led color	Nominal lm	Beam spread
W= max 3000K	max 445 lm	M = 30°
min. 1800K	min. 10 lm	S = 18°

© (m-M) Driver		
<b>3KIT.352.W15</b> (1-1)	DALI	€ 67,00
<b>3KIT.354.W10</b> (1-1)	IGBT - TRIAC	€ 30,00

(m-M) = min. Led unit - Max Led unit. Led and Emergency unit, warranty only when used together with driver bought from Oty srl.

**Pop X3 NaNo** Ø 10,0 trimless

For plasterboard. Per cartongesso

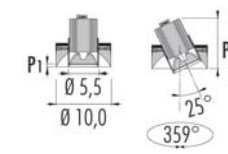

IP40	Flicker < 20%	CE	▽	□
220V ÷ 240V	<b>LED 9,5W</b>	CRI>90		
<b>3NX3.K</b>	dimmi IGBT - TRIAC	€ 155,00		
<b>4NX3.K</b>	dimmi IGBT - TRIAC	€ 165,00		
<i>With honeycomb. Con frangiluce</i>				

Led color	Nominal lm	Beam spread
2 = 2700K	710	M = 36°
3 = 3000K	760	S = 24°

Pop NaNo NX3	P	P1
3NX3.K	9,5	0,5
4NX3.K	9,9	0,5
3NX3.3  M. □	6,1	0,5
3NX3.3  S. □	6,1	0,5
3NX3.3  T. □	6,1	0,5
4NX3.3  M. □	6,6	0,5
4NX3.3  S. □	6,6	0,5
4NX3.3  T. □	6,6	0,5

Housing for plasterboard - Cassaforma cartongesso Ø 11,4cm

- **1Z00.100.01** € 55,00

□ **Frame - Struttura**

- 02 ● Black - Nero
- 06 ○ White - Bianco

(m-M) = gestione minima e massima delle unità Led. I Led e le unità di emergenza, sono coperti da garanzia solo se utilizzati in abbinamento con i driver forniti dalla Oty srl.

**easy Pop X3** Ø 10,0 with trim

For plasterboard and brickwork. Per cartongesso e laterizio

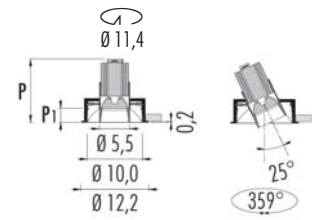

IP40	Flicker < 20%	CE	▽	□
220V ÷ 240V	<b>LED 9,5W</b>	CRI>90		
<b>3EX3.K</b> ■■▲□	dimmi IGBT - TRIAC	€ 220,00		
<b>4EX3.K</b> ■■▲□	dimmi IGBT - TRIAC	€ 230,00		
With honeycomb				

Led color	Nominal lm	Beam spread
2 = 2700K	710	M = 36°
3 = 3000K	760	S = 24°

easy Pop EX3		P	P1
3EX3.K ■■▲□	led 9,5W IP40	11,4	2,5
4EX3.K ■■▲□	led 9,5W IP40+honeycomb	11,9	2,5
3EX3.3 ■■M□	led IP40	9,0	0,5
3EX3.3 ■■S□	led IP40	11,0	2,5
3EX3.3 ■■T□	led IP40	9,0	0,5
4EX3.3 ■■M□	led IP40+honeycomb	9,5	0,5
4EX3.3 ■■S□	led IP40+honeycomb	11,5	2,5
4EX3.3 ■■T□	led IP40+honeycomb	9,5	0,5
3EX3.3WM□	led IP40	6,8	0,5
3EX3.3WS□	led IP40	8,8	2,5
4EX3.3WM□	led IP40+honeycomb	7,3	0,5
4EX3.3WS□	led IP40+honeycomb	9,3	2,5

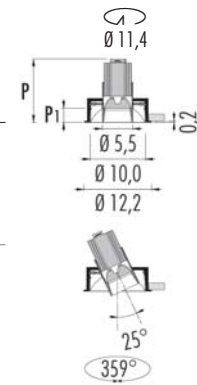

IP40	MC-E=3	CE	▽	⊕
350m/A	<b>LED 11W</b>	CRI>95		
<b>3EX3.3</b> ■■▲□		€ 220,00		
<b>4EX3.3</b> ■■▲□		€ 230,00		
With honeycomb. Con frangiluce				

Led color	Nominal lm	Beam spread
2 = 2700K	1195	M = 38°
3 = 3000K	1257	S = 22°
4 = 4000K	1313	T = 10°

© (m-M)	Driver	
<b>3KIT.350.1L</b> (1-1)	on/off	€ 21,00
<b>3KIT.351.40</b> (1-3)	DALI - Push - 1...10V remote installation - in remoto	€ 125,00
<b>3KIT.352.15</b> (1-1)	DALI	€ 67,00
<b>3KIT.353.15</b> (1-1)	Push - 1...10V	€ 62,00
<b>3KIT.354.18</b> (1-1)	IGBT - TRIAC	€ 32,00

Emergency unit: (inverter + battery. Driver not included)

<b>3KIT.900.01</b> (1-1)	1:00 hour	€ 110,00
<b>3KIT.900.03</b> (1-1)	3:00 hours	€ 145,00

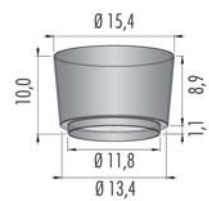

Housing for brickwork - Cassaforma laterizio

<b>1E00.100.01</b>	€ 50,00
--------------------	---------

□ Frame - Struttura

- 02 ● Black - Nero  
06 ○ White - Bianco

IP40	DimToWarm	CE	▽	⊕
350m/A	LED 6W	CRI 95		
<b>3EX3.3W</b> ■■▲□		€ 230,00		
<b>4EX3.3W</b> ■■▲□		€ 240,00		
With honeycomb. Con frangiluce				

Led color	Nominal lm	Beam spread
W= max 3000K min. 1800K	max 445 lm min. 10 lm	M = 30° S = 18°

© (m-M)	Driver	
<b>3KIT.352.W15</b> (1-1)	DALI	€ 67,00
<b>3KIT.354.W10</b> (1-1)	IGBT - TRIAC	€ 30,00

(m-M) = min. Led unit - Max Led unit. Led and Emergency unit, warranty only when used together with driver bought from Oty srl.

**easy Pop X3 NaNo** Ø 10,0 with trim

For plasterboard and brickwork. Per cartongesso e laterizio

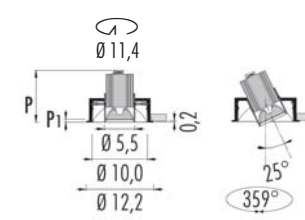

IP40	Flicker < 20%	CE	▽	□
220V ÷ 240V	<b>LED 9,5W</b>	CRI>90		
<b>3FX3.K</b> ■■▲□	dimmi IGBT - TRIAC	€ 220,00		
<b>4FX3.K</b> ■■▲□	dimmi IGBT - TRIAC	€ 230,00		
With honeycomb. Con frangiluce				

Led color	Nominal lm	Beam spread
2 = 2700K	710	M = 36°
3 = 3000K	760	S = 24°

easy NaNo Pop FX3		P	P1
3FX3.K ■■▲□	led 9,5W IP40	9,5	0,5
4FX3.K ■■▲□	led 9,5W IP40+honeycomb	9,9	0,5
3FX3.3 ■■M□	led IP40	6,1	0,5
3FX3.3 ■■S□	led IP40	6,1	0,5
3FX3.3 ■■T□	led IP40	6,1	0,5
4FX3.3 ■■M□	led IP40+honeycomb	6,6	0,5
4FX3.3 ■■S□	led IP40+honeycomb	6,6	0,5
4FX3.3 ■■T□	led IP40+honeycomb	6,6	0,5

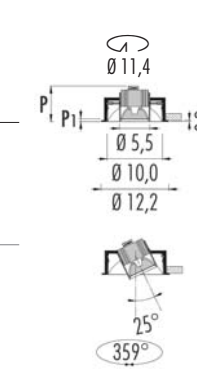

IP40	MC-E=3	CE	▽	⊕
250m/A	<b>LED 8W</b>	CRI>95		
<b>3FX3.3</b> ■■▲□		€ 220,00		
<b>4FX3.3</b> ■■▲□		€ 230,00		
With honeycomb. Con frangiluce				

Led color	Nominal lm	Beam spread
2 = 2700K	779	M = 38°
3 = 3000K	819	S = 22°
4 = 4000K	855	T = 10°

© (m-M)	Driver	
<b>3KIT.250.1L</b> (1-1)	on/off	€ 21,00
<b>3KIT.251.28</b> (1-3)	DALI - Push - 1...10V remote installation - in remoto	€ 125,00
<b>3KIT.252.12</b> (1-1)	DALI	€ 67,00
<b>3KIT.253.13</b> (1-1)	Push - 1...10V	€ 62,00
<b>3KIT.254.12</b> (1-1)	IGBT - TRIAC	€ 32,00

Emergency unit: (inverter + battery. Driver not included)

<b>3KIT.900.01</b> (1-1)	1:00 hour	€ 110,00
<b>3KIT.900.03</b> (1-1)	3:00 hours	€ 145,00

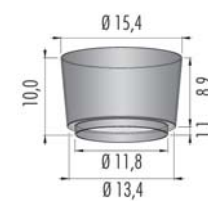

Housing for brickwork - Cassaforma laterizio

<b>1E00.100.01</b>	€ 50,00
--------------------	---------

□ Frame - Struttura

- 02 ● Black - Nero  
06 ○ White - Bianco

(m-M) = gestione minima e massima delle unità Led. I Led e le unità di emergenza, sono coperti da garanzia solo se utilizzati in abbinamento con i driver forniti dalla Oty srl.

**Pop Y3 Ø 10,0 trimless**

For plasterboard. Per cartongesso

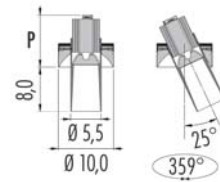

Pop PY3		P
3PY3.K S.□	led 9,5W IP40	9,5
4PY3.K S.□	led 9,5W IP40 + honeycomb	9,9
3PY3.3 S.□	led IP40	8,5
4PY3.3 S.□	led IP40 + honeycomb	9,0
3PY3.3WS.□	led IP40	6,1
4PY3.3WS.□	led IP40 + honeycomb	6,6

Pop NY3 NaNo		P
3NY3.3 S.□	led IP40	5,5
4NY3.3 S.□	led IP40 + honeycomb	6,0

□ Frame - Struttura

- 02 ● Black - Nero  
06 ○ White - Bianco

IP40	Flicker < 20%	CE	▽	□
220V ÷ 240V	<b>LED 9,5W</b>	CRI>90		
3PY3.K S.□	dimmi IGBT - TRIAC	€ 175,00		
4PY3.K S.□	dimmi IGBT - TRIAC	€ 185,00		
<i>With honeycomb. Con frangiluce</i>				

Led color	Nominal lm	Beam spread
2 = 2700K	710	20°
3 = 3000K	760	

IP40	MC-E=3	CE	▽	⊕
250m/A	<b>LED 11W</b>	CRI>95		
3PY3.3 S.□		€ 175,00		
4PY3.3 S.□		€ 185,00		
<i>With honeycomb. Con frangiluce</i>				

Led color	Nominal lm	Beam spread
2 = 2700K	1195	20°
3 = 3000K	1257	
4 = 4000K	1313	

© (m-M) Driver		
3KIT.350.1L (1-1)	on/off	€ 21,00
3KIT.351.40 (1-3)	DALI - Push - 1...10V <i>remote installation - in remoto</i>	€ 125,00
3KIT.352.15 (1-1)	DALI	€ 67,00
3KIT.353.15 (1-1)	Push - 1...10V	€ 62,00
3KIT.354.18 (1-1)	IGBT - TRIAC	€ 32,00

Emergency unit: (inverter + battery. Driver not included)

3KIT.900.01 (1-1)	1:00 hour	€ 110,00
3KIT.900.03 (1-1)	3:00 hours	€ 145,00

IP40	DimToWarm	CE	▽	⊕
350m/A	LED 6W	CRI 95		
3PY3.3WS.□		€ 185,00		
4PY3.3WS.□		€ 195,00		
<i>With honeycomb. Con frangiluce</i>				

Led color	Nominal lm	Beam spread
W= max 3000K min. 1800K	max 445 lm min. 10 lm	18°

© (m-M) Driver		
3KIT.352.W15 (1-1)	DALI	€ 67,00
3KIT.354.W10 (1-1)	IGBT - TRIAC	€ 30,00

(m-M) = min. Led unit - Max Led unit. Led and Emergency unit, warranty only when used together with driver bought from Oty srl.

**Pop Y3 NaNo Ø 10,0 trimless**

For plasterboard. Per cartongesso

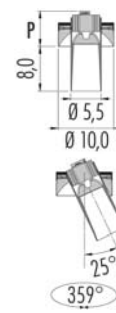

IP40	MC-E=3	CE	▽	⊕
250m/A	<b>LED 8W</b>	CRI>95		
3NY3.3 S.□		€ 175,00		
4NY3.3 S.□		€ 185,00		
<i>With honeycomb. Con frangiluce</i>				

Led color	Nominal lm	Beam spread
2 = 2700K	779	20°
3 = 3000K	819	
4 = 4000K	855	

© (m-M) Driver		
3KIT.250.1L (1-1)	on/off	€ 21,00
3KIT.251.28 (1-3)	DALI - Push - 1...10V <i>remote installation - in remoto</i>	€ 125,00
3KIT.252.12 (1-1)	DALI	€ 67,00
3KIT.253.13 (1-1)	Push - 1...10V	€ 62,00
3KIT.254.12 (1-1)	IGBT - TRIAC	€ 32,00

Emergency unit: (inverter + battery. Driver not included)

3KIT.900.01 (1-1)	1:00 hour	€ 110,00
3KIT.900.03 (1-1)	3:00 hours	€ 145,00

Housing for plasterboard - Cassaforma cartongesso Ø 11,4cm

● 1Z00.100.01	€ 55,00
---------------	---------

**easy Pop Y3 Ø 10,0 with trim**

For plasterboard and brickwork. Per cartongesso e laterizio

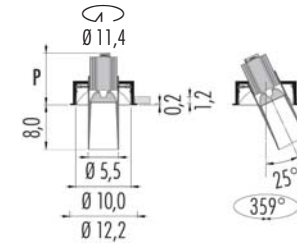

easy Pop EY3		P
3EY3.K S.□	led 9,5W IP40	9,5
4EY3.K S.□	led 9,5W IP40 + honeycomb	9,9
3EY3.3 S.□	led IP40	8,5
4EY3.3 S.□	led IP40 + honeycomb	9,0
3EY3.3WS.□	led IP40	6,1
4EY3.3WS.□	led IP40 + honeycomb	6,6

easy Pop NY3 NaNo		P
3FY3.3 S.□	led IP40	5,5
4FY3.3 S.□	led IP40 + honeycomb	6,0

□ Frame - Struttura

- 02 ● Black - Nero  
06 ○ White - Bianco

IP40	Flicker < 20%	CE	▽	□
220V ÷ 240V	<b>LED 9,5W</b>	CRI>90		
3EY3.K S.□	dimmi IGBT - TRIAC	€ 230,00		
4EY3.K S.□	dimmi IGBT - TRIAC	€ 240,00		
<i>With honeycomb. Con frangiluce</i>				

Led color	Nominal lm	Beam spread
2 = 2700K	710	20°
3 = 3000K	760	

IP40	MC-E=3	CE	▽	⊕
350m/A	<b>LED 11W</b>	CRI>95		
3EY3.3 S.□		€ 230,00		
4EY3.3 S.□		€ 240,00		
<i>With honeycomb. Con frangiluce</i>				

Led color	Nominal lm	Beam spread
2 = 2700K	1195	20°
3 = 3000K	1257	
4 = 4000K	1313	

© (m-M) Driver		
3KIT.350.1L (1-1)	on/off	€ 21,00
3KIT.351.40 (1-3)	DALI - Push - 1...10V <i>Remote installation</i>	€ 125,00
3KIT.352.15 (1-1)	DALI	€ 67,00
3KIT.353.15 (1-1)	Push - 1...10V	€ 62,00
3KIT.354.18 (1-1)	IGBT - TRIAC	€ 32,00

Emergency unit: (inverter + battery. Driver not included)

3KIT.900.01 (1-1)	1:00 hour	€ 110,00
3KIT.900.03 (1-1)	3:00 hours	€ 145,00

IP40	DimToWarm	CE	▽	⊕
350m/A	LED 6W	CRI 95		
3EY3.3WS.□		€ 240,00		
4EY3.3WS.□		€ 250,00		
<i>With honeycomb. Con frangiluce</i>				

Led color	Nominal lm	Beam spread
W= max 3000K min. 1800K	max 445 lm min. 10 lm	18°

© (m-M) Driver		
3KIT.352.W15 (1-1)	DALI	€ 67,00
3KIT.354.W10 (1-1)	IGBT - TRIAC	€ 30,00

(m-M) = gestione minima e massima delle unità Led. I Led e le unità di emergenza, sono coperti da garanzia solo se utilizzati in abbinamento con i driver forniti dalla Oty srl.

**easy Pop Y3 NaNo Ø 10,0 with trim**

For plasterboard and brickwork. Per cartongesso e laterizio

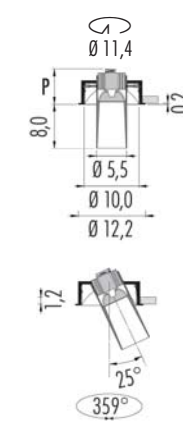

IP40	MC-E=3	CE	▽	⊕
250m/A	<b>LED 8W</b>	CRI>95		
3FY3.3 S.□		€ 230,00		
4FY3.3 S.□		€ 240,00		
<i>With honeycomb. Con frangiluce</i>				

Led color	Nominal lm	Beam spread
2 = 2700K	779	20°
3 = 3000K	879	
4 = 4000K	855	

© (m-M) Driver		
3KIT.250.1L (1-1)	on/off	€ 21,00
3KIT.251.28 (1-3)	DALI - Push - 1...10V <i>remote installation - in remoto</i>	€ 125,00
3KIT.252.12 (1-1)	DALI	€ 67,00
3KIT.253.13 (1-1)	Push - 1...10V	€ 62,00
3KIT.254.12 (1-1)	IGBT - TRIAC	€ 32,00

Emergency unit: (inverter + battery. Driver not included)

3KIT.900.01 (1-1)	1:00 hour	€ 110,00
3KIT.900.03 (1-1)	3:00 hours	€ 145,00

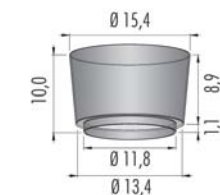

Housing for brickwork - Cassaforma laterizio

1E00.100.01	€ 50,00
-------------	---------



**Pop Y3 Ø 10,0 Glass trimless**

For plasterboard. Per cartongesso

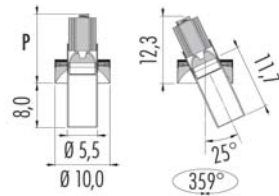

IP40	Flicker <20%	CE	▽	⊕
220V ÷ 240V	<b>LED 9,5W</b>	CRI>90		
<b>3PY3.K</b>	dimm IGBT - TRIAC	€ 190,00		
<b>4PY3.K</b>	dimm IGBT - TRIAC	€ 200,00		
<i>With honeycomb. Con frangiluce</i>				
	Nominal lm		Beam spread	
2 = 2700K	710	M = 36°		
3 = 3000K	760	S = 24°		

IP40	MC-E=3	CE	▽	⊕
350m/A	<b>LED 11W</b>	CRI>95		
<b>3PY3.3</b>		€ 190,00		
<b>4PY3.3</b>		€ 200,00		
<i>With honeycomb. Con frangiluce</i>				
	Nominal lm		Beam spread	
2 = 2700K	1195	M = 38°		
3 = 3000K	1257	S = 22°		
4 = 4000K	1313	T = 10°		

© (m-M)	Driver	€	
<b>3KIT.350.1L</b> (1-1)	on/off	€ 21,00	
<b>3KIT.351.40</b> (1-3)	DALI - Push - 1...10V <i>remote installation - in remoto</i>	€ 125,00	
<b>3KIT.352.15</b> (1-1)	DALI	€ 67,00	
<b>3KIT.353.15</b> (1-1)	Push - 1...10V	€ 62,00	
<b>3KIT.354.18</b> (1-1)	IGBT - TRIAC	€ 32,00	

Emergency unit: (inverter + battery. Driver not included)

<b>3KIT.900.01</b> (1-1)	1:00 hour	€ 110,00
<b>3KIT.900.03</b> (1-1)	3:00 hours	€ 145,00

IP40	DimToWarm	CE	▽	⊕
350m/A	LED 6W	CRI 95		
<b>3PY3.3WS.</b>		€ 210,00		
<b>4PY3.3WS.</b>		€ 220,00		
<i>With honeycomb. Con frangiluce</i>				
	Nominal lm		Beam spread	
W= max 3000K	max 445 lm	M = 30°		
min. 1800K	min. 10 lm	S = 18°		

© (m-M)	Driver	€	
<b>3KIT.352.W15</b> (1-1)	DALI	€ 67,00	
<b>3KIT.354.W10</b> (1-1)	IGBT - TRIAC	€ 30,00	

**Pop Y3 NaNo Glass Ø 10,0 trimless**

For plasterboard. Per cartongesso

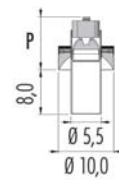

IP40	MC-E=3	CE	▽	⊕
250m/A	<b>LED 8W</b>	CRI>95		
<b>3NY3.3</b>		€ 190,00		
<b>4NY3.3</b>		€ 200,00		
<i>With honeycomb. Con frangiluce</i>				
	Nominal lm		Beam spread	
2 = 2700K	779	M = 38°		
3 = 3000K	879	S = 22°		
4 = 4000K	855	T = 10°		

© (m-M)	Driver	€	
<b>3KIT.250.1L</b> (1-1)	on/off	€ 21,00	
<b>3KIT.251.28</b> (1-3)	DALI - Push - 1...10V <i>remote installation - in remoto</i>	€ 125,00	
<b>3KIT.252.12</b> (1-1)	DALI	€ 67,00	
<b>3KIT.253.13</b> (1-1)	Push - 1...10V	€ 62,00	
<b>3KIT.254.12</b> (1-1)	IGBT - TRIAC	€ 32,00	

Emergency unit: (inverter + battery. Driver not included)

<b>3KIT.900.01</b> (1-1)	1:00 hour	€ 110,00
<b>3KIT.900.03</b> (1-1)	3:00 hours	€ 145,00

□	Frame - Struttura	Glass - Vetro
02F	Black - Nero	Fumé
06T	White - Bianco	Transparent

●	Housing for plasterboard - Cassaforma cartongesso	Ø 11,4cm	€	
<b>1200.100.01</b>			€ 55,00	

(m-M) = min. Led unit - Max Led unit. Led and Emergency unit, warranty only when used together with driver bought from Oty srl.

**easy Pop Y3 Ø 10,0 Glass with trim**

For plasterboard and brickwork. Per cartongesso e laterizio

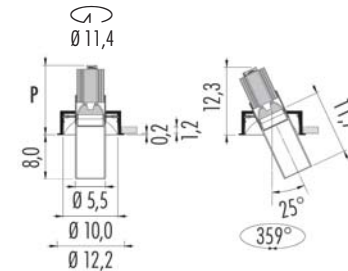

IP40	Flicker <20%	CE	▽	⊕
220V ÷ 240V	<b>LED 9,5W</b>	CRI>90		
<b>3EY3.K</b>	dimm IGBT - TRIAC	€ 260,00		
<b>4EY3.K</b>	dimm IGBT - TRIAC	€ 270,00		
<i>With honeycomb. Con frangiluce</i>				
	Nominal lm		Beam spread	
2 = 2700K	710	M = 36°		
3 = 3000K	760	S = 24°		

IP40	MC-E=3	CE	▽	⊕
350m/A	<b>LED 11W</b>	CRI>95		
<b>3EY3.3</b>		€ 260,00		
<b>4EY3.3</b>		€ 270,00		
<i>With honeycomb. Con frangiluce</i>				
	Nominal lm		Beam spread	
2 = 2700K	1195	M = 38°		
3 = 3000K	1257	S = 22°		
4 = 4000K	1313	T = 10°		

© (m-M)	Driver	€	
<b>3KIT.350.1L</b> (1-1)	on/off	€ 21,00	
<b>3KIT.351.40</b> (1-3)	DALI - Push - 1...10V <i>remote installation - in remoto</i>	€ 125,00	
<b>3KIT.352.15</b> (1-1)	DALI	€ 67,00	
<b>3KIT.353.15</b> (1-1)	Push - 1...10V	€ 62,00	
<b>3KIT.354.18</b> (1-1)	IGBT - TRIAC	€ 32,00	

Emergency unit: (inverter + battery. Driver not included)

<b>3KIT.900.01</b> (1-1)	1:00 hour	€ 110,00
<b>3KIT.900.03</b> (1-1)	3:00 hours	€ 145,00

IP40	DimToWarm	CE	▽	⊕
350m/A	LED 6W	CRI 95		
<b>3EY3.3WS.</b>		€ 270,00		
<b>4EY3.3WS.</b>		€ 280,00		
<i>With honeycomb. Con frangiluce</i>				
	Nominal lm		Beam spread	
W= max 3000K	max 445 lm	M = 30°		
min. 1800K	min. 10 lm	S = 18°		

© (m-M)	Driver	€	
<b>3KIT.352.W15</b> (1-1)	DALI	€ 67,00	
<b>3KIT.354.W10</b> (1-1)	IGBT - TRIAC	€ 30,00	

(m-M) = gestione minima e massima delle unità Led. I Led e le unità di emergenza, sono coperti da garanzia solo se utilizzati in abbinamento con i driver forniti dalla Oty srl.

**easy Pop Y3 NaNo Glass Ø 10,0 with trim**

For plasterboard and brickwork. Per cartongesso e laterizio

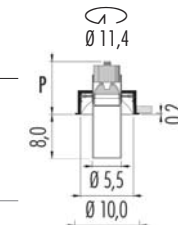

IP40	MC-E=3	CE	▽	⊕
250m/A	<b>LED 8W</b>	CRI>95		
<b>3FY3.3</b>		€ 260,00		
<b>4FY3.3</b>		€ 270,00		
<i>With honeycomb. Con frangiluce</i>				
	Nominal lm		Beam spread	
2 = 2700K	779	M = 38°		
3 = 3000K	879	S = 22°		
4 = 4000K	855	T = 10°		

© (m-M)	Driver	€	
<b>3KIT.250.1L</b> (1-1)	on/off	€ 21,00	
<b>3KIT.251.28</b> (1-3)	DALI - Push - 1...10V <i>remote installation - in remoto</i>	€ 125,00	
<b>3KIT.252.12</b> (1-1)	DALI	€ 67,00	
<b>3KIT.253.13</b> (1-1)	Push - 1...10V	€ 62,00	
<b>3KIT.254.12</b> (1-1)	IGBT - TRIAC	€ 32,00	

Emergency unit: (inverter + battery. Driver not included)

<b>3KIT.900.01</b> (1-1)	1:00 hour	€ 110,00
<b>3KIT.900.03</b> (1-1)	3:00 hours	€ 145,00

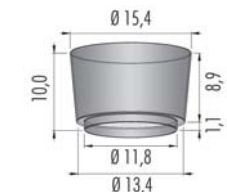

●	Housing for brickwork - Cassaforma laterizio	€	
<b>1E00.100.01</b>		€ 50,00	

### Pop Z3 Ø 10,0 trimless

For plasterboard. Per cartongesso

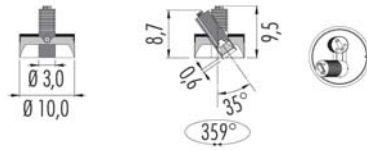

IP40	MC-E=3	CE	▽	⊕
500m/A	LED 2x6W	CRI>90		
<b>3PZ3.2</b> ■ M. □		€	<b>265,00</b>	
■ Led color	Nominal lm	▲ Beam spread		
2 = 2700K	2x528	25°		
3 = 3000K	2x552			

© (to order) Driver

<b>3KIT.500.15</b> (n° 2) on/off	€	<b>30,00</b>
<b>3KIT.501.50</b> (n° 1) DALI - Push - 1...10V	€	<b>125,00</b>
<b>3KIT.502.20</b> (n° 1) DALI	€	<b>67,00</b>
<b>3KIT.503.20</b> (n° 1) Push - 1...10	€	<b>62,00</b>
<b>3KIT.504.10</b> (n° 2) IGBT - TRIAC	€	<b>32,00</b>

Emergency unit: (inverter + battery. Driver not included)

<b>3KIT.900.01</b> (1-1) 1:00 hour	€	<b>110,00</b>
<b>3KIT.900.03</b> (1-1) 3:00 hours	€	<b>145,00</b>

Housing for plasterboard - Cassaforma cartongesso ↻ Ø 11,4cm

● <b>1Z00.100.01</b>	€	<b>55,00</b>
----------------------	---	--------------

□ Frame - Struttura

<b>02</b> ● Black - Nero
<b>06</b> ○ White - Bianco

(m-M) = min. Led unit - Max Led unit. Led and Emergency unit, warranty only when used together with driver bought from Oty srl.

### easy Pop Z3 Ø 10,0 with trim

For plasterboard and brickwork. Per cartongesso e laterizio

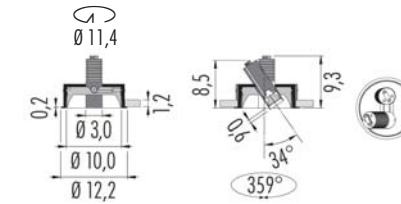

IP40	MC-E=3	CE	▽	⊕
500m/A	LED 2x6W	CRI>90		
<b>3EZ3.2</b> ■ M. □		€	<b>320,00</b>	
■ Led color	Nominal lm	▲ Beam spread		
2 = 2700K	2x528	25°		
3 = 3000K	2x552			

© (to order) Driver

<b>3KIT.500.15</b> (n° 2) on/off	€	<b>30,00</b>
<b>3KIT.501.50</b> (n° 1) DALI - Push - 1...10V	€	<b>125,00</b>
<b>3KIT.502.20</b> (n° 1) DALI	€	<b>67,00</b>
<b>3KIT.503.20</b> (n° 1) Push - 1...10	€	<b>62,00</b>
<b>3KIT.504.10</b> (n° 2) IGBT - TRIAC	€	<b>32,00</b>

Emergency unit: (inverter + battery. Driver not included)

<b>3KIT.900.01</b> (1-1) 1:00 hour	€	<b>110,00</b>
<b>3KIT.900.03</b> (1-1) 3:00 hours	€	<b>145,00</b>

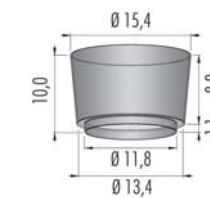

Housing for brickwork - Cassaforma laterizio

<b>1E00.100.01</b>	€	<b>50,00</b>
--------------------	---	--------------

□ Frame - Struttura

<b>02</b> ● Black - Nero
<b>06</b> ○ White - Bianco

(m-M) = gestione minima e massima delle unità Led. I Led e le unità di emergenza, sono coperti da garanzia solo se utilizzati in abbinamento con i driver forniti dalla Oty srl.

**Pop 03 Look** Ø 17,0 trimless

For plasterboard. Per cartongesso

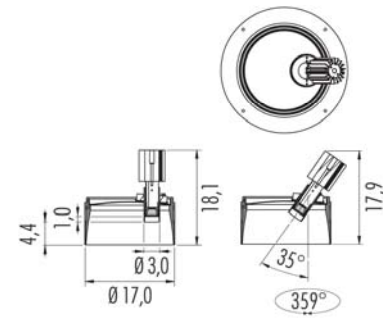
**Look x1**

IP40	MC-E=3	CE	V	⊕
350m/A	LED 1x13,4W	CRI>95		
3PL31.2	M.□	€ 270,00		
4PL31.2	M.□	€ 280,00		
With honeycomb. Con frangiluce				

Led color	Nominal lm	Beam spread
2 = 2700K	1650	30°
3 = 3000K	1727	
4 = 4000K	1786	

© (to order) Driver		€
3KIT.350.1L (n° 1) on/off		21,00
3KIT.352.15 (n° 1) DALI		67,00
3KIT.353.15 (n° 1) Push - 1...10V		62,00
3KIT.354.18 (n° 1) IGBT - TRIAC		32,00

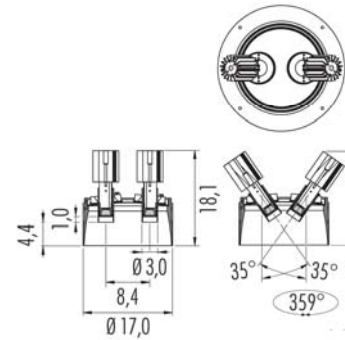
**Look x2**

IP40	MC-E=3	CE	V	⊕
350m/A	LED 2x13,4W	CRI>95		
3PL32.2	M.□	€ 400,00		
4PL32.2	M.□	€ 420,00		
With honeycomb. Con frangiluce				

Led color	Nominal lm	Beam spread
2 = 2700K	2x1650	30°
3 = 3000K	2x1727	
4 = 4000K	2x1786	

© (to order) Driver		€
3KIT.350.1L (n° 2) on/off		21,00
3KIT.351.40 (n° 1) DALI - Push - 1...10V		125,00
3KIT.354.18 (n° 2) IGBT - Triac		32,00

Housing for plasterboard - Cassaforma cartongesso ↻ Ø 19,0 cm

- 1K00.170.01 € 85,00

□	Frame - Struttura
02 ●	Black - Nero
06 ○	White - Bianco

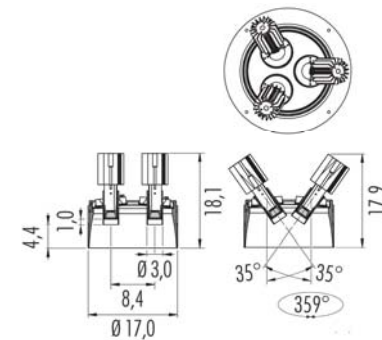
**Look x3**

IP40	MC-E=3	CE	V	⊕
350m/A	LED 3x13,4W	CRI>95		
3PL33.2	M.□	€ 530,00		
4PL33.2	M.□	€ 560,00		
With honeycomb. Con frangiluce				

Led color	Nominal lm	Beam spread
2 = 2700K	3x1650	30°
3 = 3000K	3x1727	
4 = 4000K	3x1786	

© (to order) Driver		€
3KIT.350.1L (n° 3) on/off		21,00
3KIT.352.15 (n° 3) DALI		67,00
3KIT.353.15 (n° 3) Push - 1...10V		62,00
3KIT.354.18 (n° 3) IGBT - Triac		32,00

(m-M) = min. Led unit - Max Led unit. Led and Emergency unit, warranty only when used together with driver bought from Oty srl.

**Pop 04** Ø 8,0 trimless

For plasterboard. Per cartongesso

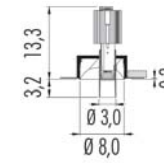

IP40	CE	V	⊕
350m/A	LED 13,4W	CRI>95	
3P04.2	S.□	€ 135,00	
4P04.2	S.□	€ 145,00	
With honeycomb. Con frangiluce			

Led color	Nominal lm	Beam spread
2 = 2700K	1650	25°
3 = 3000K	1727	
4 = 4000K	1786	

© (m-M) Driver		€
3KIT.350.1L (1-1) on/off		21,00
3KIT.351.40 (1-2) DALI - Push - 1...10V	remote installation - in remoto	125,00
3KIT.352.15 (1-1) DALI		67,00
3KIT.353.15 (1-1) Push - 1...10V		62,00
3KIT.354.18 (1-1) IGBT - TRIAC		32,00

Emergency unit: (inverter + battery. Driver not included)		
3KIT.900.01 (1-1) 1:00 hour		€ 110,00
3KIT.900.03 (1-1) 3:00 hours		€ 145,00

Housing for plasterboard - Cassaforma cartongesso ↻ Ø 9,5cm

- 1Z00.080.01 Single € 55,00
- 1Z00.080.2L Double € 110,00
- 1Z00.080.3L Triple € 150,00

□	Frame - Struttura
02 ●	Black - Nero
06 ○	White - Bianco

(m-M) = gestione minima e massima delle unità Led. I Led e le unità di emergenza, sono coperti da garanzia solo se utilizzati in abbinamento con i driver forniti dalla Oty srl.

**easy Pop 04** Ø 8,0 with trim

For plasterboard and brickwork. Per cartongesso e laterizio

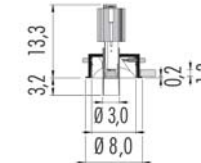

IP40	CE	V	⊕
350m/A	LED 13,4W	CRI>95	
3E04.2	S.□	€ 230,00	
4E04.2	S.□	€ 240,00	
With honeycomb. Con frangiluce			

Led color	Nominal lm	Beam spread
2 = 2700K	1650	25°
3 = 3000K	1727	
4 = 4000K	1786	

© (m-M) Driver		€
3KIT.350.1L (1-1) on/off		21,00
3KIT.351.40 (1-2) DALI - Push - 1...10V	remote installation - in remoto	125,00
3KIT.352.15 (1-1) DALI		67,00
3KIT.353.15 (1-1) Push - 1...10V		62,00
3KIT.354.18 (1-1) IGBT - TRIAC		32,00

Emergency unit: (inverter + battery. Driver not included)		
3KIT.900.01 (1-1) 1:00 hour		€ 110,00
3KIT.900.03 (1-1) 3:00 hours		€ 145,00

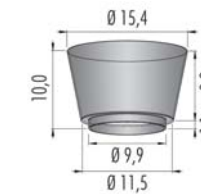

Housing for brickwork - Cassaforma laterizio

- 1E00.080.01 € 50,00

□	Frame - Struttura
02 ●	Black - Nero
06 ○	White - Bianco

**Pop 04**  $\varnothing$  12,0 trimless

For plasterboard and brickwork. Per cartongesso e laterizio

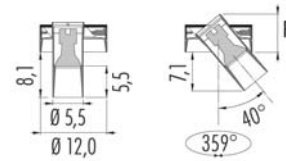

IP20	CE	▽	□
220V ÷ 240V			
<b>3P04.210.</b> □	<b>GU10</b> max 50W	€	<b>130,00</b>
<b>3P04.211.</b> □	<b>GU10</b> led	€	<b>130,00</b>
<b>4P04.211.</b> □	<b>GU10</b> led	€	<b>140,00</b>
<i>With honeycomb - Con frangiluce</i>			

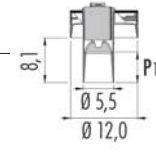

IP40	MC-E=3	CE	▽	⊕
350m/A	<b>LED 11W</b>	CRI>95		
<b>3P04.3</b> ■▲□		€	<b>195,00</b>	
<b>4P04.3</b> ■▲□		€	<b>205,00</b>	
<i>With honeycomb - Con frangiluce</i>				

Led color	Nominal lm	Beam spread
2 = 2700K	1195	M = 38°
3 = 3000K	1257	S = 22°
4 = 4000K	1313	T = 12°

© (m-M)	Driver	
<b>3KIT.350.1L</b> (1-1)	on/off	€ <b>21,00</b>
<b>3KIT.351.40</b> (1-3)	DALI - Push - 1...10V <i>remote installation - in remoto</i>	€ <b>125,00</b>
<b>3KIT.352.15</b> (1-1)	DALI	€ <b>67,00</b>
<b>3KIT.353.15</b> (1-1)	Push - 1...10V	€ <b>62,00</b>
<b>3KIT.354.18</b> (1-1)	IGBT - TRIAC	€ <b>32,00</b>

Emergency unit: (inverter + battery. Driver not included)

<b>3KIT.900.01</b> (1-1)	1:00 hour	€ <b>110,00</b>
<b>3KIT.900.03</b> (1-1)	3:00 hours	€ <b>145,00</b>

Pop PO4

Pop PO4	P
<b>3P04.210.</b> □ GU10	8,4
<b>3P04.211.</b> □ GU10 led	—
<b>4P04.211.</b> □ GU10 led + honeycomb	—
<b>3P04.220.</b> □ GU5.3	6,8
<b>4P04.220.</b> □ GU5.3 led + honeycomb	—

IP20

IP20	CE	▽	⊕
12V			
<b>3P04.220.</b> □	<b>GU5.3</b> max 50W	€	<b>130,00</b>
<b>4P04.220.</b> □	<b>GU5.3</b> led	€	<b>140,00</b>
<i>With honeycomb</i>			
<b>3KIT.201.050</b>	max 50VA	€	<b>35,00</b>

Pop PO4 Led

Pop PO4 Led	P	P1
<b>3P04.3</b> ■ M. □ led IP40	6,8	2,5
<b>3P04.3</b> ■ S. □ led IP40	6,8	5,5
<b>3P04.3</b> ■ T. □ led IP40	6,8	2,5
<b>4P04.3</b> ■ M. □ led IP40 + honeycomb	6,8	2,5
<b>4P04.3</b> ■ S. □ led IP40 + honeycomb	7,4	5,5
<b>4P04.3</b> ■ T. □ led IP40 + honeycomb	6,8	2,5

Housing for plasterboard - Cassaforma cartongesso  $\curvearrowright$   $\varnothing$  14,0cm

- **1Z00.120.01** Single € **60,00**
- **1Z00.120.2L** Double € **105,00**

Housing for brickwork - Cassaforma laterizio

- **1M00.120.01** € **140,00**

□ Frame - Struttura

- 02 ● Black - Nero
- 06 ○ White - Bianco

(m-M) = min. Led unit - Max Led unit. Led and Emergency unit, warranty only when used together with driver bought from Oty srl.

**Pop 04A Magic**  $\varnothing$  3,0 trimless

For plasterboard. Per cartongesso

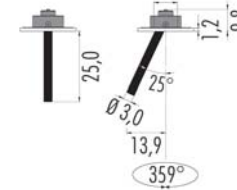

IP40	CE	▽	⊕
350m/A	<b>LED 13,4W</b>	CRI>95	
<b>3P04A.2</b> ■ M. □		€	<b>280,00</b>
<b>4P04A.2</b> ■ M. □		€	<b>290,00</b>
<i>With honeycomb - Con frangiluce</i>			

Led color	Nominal lm	Beam spread
2 = 2700K	1650	35°
3 = 3000K	1727	
4 = 4000K	1786	

© (m-M)	Driver	
<b>3KIT.350.1L</b> (1-1)	on/off	€ <b>21,00</b>
<b>3KIT.351.40</b> (1-2)	DALI - Push - 1...10V <i>remote installation - in remoto</i>	€ <b>125,00</b>
<b>3KIT.352.15</b> (1-1)	DALI	€ <b>67,00</b>
<b>3KIT.353.15</b> (1-1)	Push - 1...10V	€ <b>62,00</b>
<b>3KIT.354.18</b> (1-1)	IGBT - TRIAC	€ <b>32,00</b>

Emergency unit: (inverter + battery. Driver not included)

<b>3KIT.900.01</b> (1-1)	1:00 hour	€ <b>110,00</b>
<b>3KIT.900.03</b> (1-1)	3:00 hours	€ <b>145,00</b>

Housing for plasterboard - Cassaforma cartongesso  $\curvearrowright$   $\varnothing$  8,5cm

- **1W00.085.01** € **135,00**  
*Housing for plasterboard with 1,2cm max thickness  
Cassaforma per cartongesso con spessore max di 1,2cm*

□ Frame - Struttura

- 02 ● Black - Nero
- 06 ○ White - Bianco

(m-M) = gestione minima e massima delle unità Led. I Led e le unità di emergenza, sono coperti da garanzia solo se utilizzati in abbinamento con i driver forniti dalla Oty srl.

**Pop 04B Magic**  $\varnothing$  3,0 trimless

For plasterboard. Per cartongesso

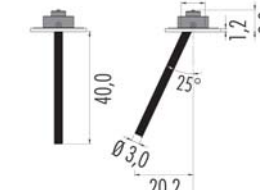

IP40	CE	▽	⊕
350m/A	<b>LED 13,4W</b>	CRI>95	
<b>3P04B.2</b> ■ M. □		€	<b>300,00</b>
<b>4P04B.2</b> ■ M. □		€	<b>310,00</b>
<i>With honeycomb - Con frangiluce</i>			

Led color	Nominal lm	Beam spread
2 = 2700K	1650	35°
3 = 3000K	1727	
4 = 4000K	1786	

© (m-M)	Driver	
<b>3KIT.350.1L</b> (1-1)	on/off	€ <b>21,00</b>
<b>3KIT.351.40</b> (1-2)	DALI - Push - 1...10V <i>remote installation - in remoto</i>	€ <b>125,00</b>
<b>3KIT.352.15</b> (1-1)	DALI	€ <b>67,00</b>
<b>3KIT.353.15</b> (1-1)	Push - 1...10V	€ <b>62,00</b>
<b>3KIT.354.18</b> (1-1)	IGBT - TRIAC	€ <b>32,00</b>

Emergency unit: (inverter + battery. Driver not included)

<b>3KIT.900.01</b> (1-1)	1:00 hour	€ <b>110,00</b>
<b>3KIT.900.03</b> (1-1)	3:00 hours	€ <b>145,00</b>

Housing for plasterboard - Cassaforma cartongesso  $\curvearrowright$   $\varnothing$  8,5cm

- **1W00.085.01** € **135,00**  
*Housing for plasterboard with 1,2cm max thickness  
Cassaforma per cartongesso con spessore max di 1,2cm*

□ Frame - Struttura

- 02 ● Black - Nero
- 06 ○ White - Bianco

**Pop 04C Magic** Ø 3,0 trimless

For plasterboard. Per cartongesso

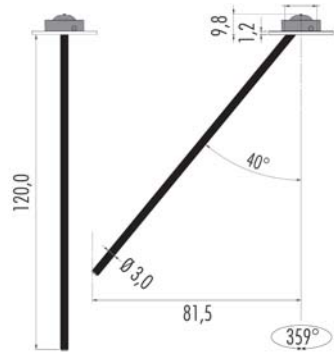

IP40	CE	▽	⊕
350m/A	<b>LED 13,4W</b>	CRI>95	
<b>3P04C.2</b> ■ M. □		€ 450,00	
<b>4P04C.2</b> ■ M. □		€ 460,00	
<i>With honeycomb - Con frangiluce</i>			
■ Led color	Nominal lm	▲ Beam spread	
2 = 2700K	1650	35°	
3 = 3000K	1727		
4 = 4000K	1786		

© (m-M)	Driver		
<b>3KIT.350.1L</b> (1-1)	on/off	€ 21,00	
<b>3KIT.351.40</b> (1-2)	DALI - Push - 1...10V <i>remote installation - in remoto</i>	€ 125,00	
<b>3KIT.352.15</b> (1-1)	DALI	€ 67,00	
<b>3KIT.353.15</b> (1-1)	Push - 1...10V	€ 62,00	
<b>3KIT.354.18</b> (1-1)	IGBT - TRIAC	€ 32,00	

Emergency unit: (inverter + battery. Driver not included)

<b>3KIT.900.01</b> (1-1)	1:00 hour	€ 110,00
<b>3KIT.900.03</b> (1-1)	3:00 hours	€ 145,00

□ Frame - Struttura

02 ● Black - Nero

06 ○ White - Bianco

Housing for plasterboard - Cassaforma cartongesso ↻ Ø 12,5cm

- **1W00.125.01** € 165,00

Housing for plasterboard with 1,2cm max thickness

Cassaforma per cartongesso con spessore max di 1,2cm

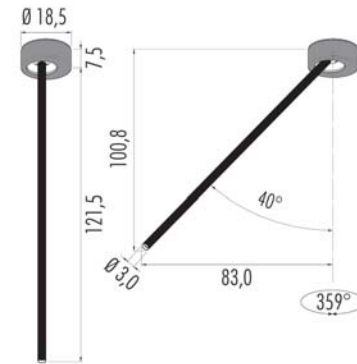
**Pop 04K Magic** Ø 3,0 ceiling - plafone **ROS**

IP40	CE	▽	⊕
220-240V	<b>LED 13,4W</b>	CRI>95	
<b>3P04K.2</b> ■ M. □	dim. IGBT - TRIAC	€ 750,00	
<b>4P04K.2</b> ■ M. □	dim. IGBT - TRIAC	€ 760,00	
<i>With honeycomb - Con frangiluce</i>			

<b>3P04KA2</b> ■ M. □	DALI	€ 800,00
<b>4P04KA2</b> ■ M. □	DALI	€ 810,00
<i>With honeycomb - Con frangiluce</i>		

<b>3P04KG2</b> ■ M. □	Push - 1...10V	€ 800,00
<b>4P04KG2</b> ■ M. □	Push - 1...10V	€ 810,00
<i>With honeycomb - Con frangiluce</i>		

■ Led color	Nominal lm	▲ Beam spread
2 = 2700K	1650	35°
3 = 3000K	1727	
4 = 4000K	1786	

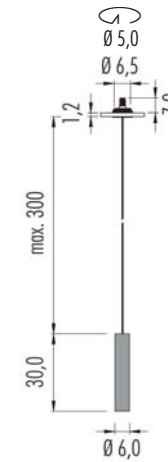
**Pop 06** Ø 6,0 Mono-color

IP20	ARC	CE	▽
220-240V			
<b>3P06A.210</b> □	GU10 1x50W	€ 290,00	

IP20	Flicker < 20%	CE	▽	MC-E=3
220-240V	9,5W	CRI>90		
<b>3P06A.K</b> ■ S. □	dim. IGBT - TRIAC	€ 330,00		
■ Led color	Nominal lm	Beam spread		
2 = 2700K	710	24°		
3 = 3000K	760			

IP20	CUP	CE	▽
220-240V			
<b>3P06.210</b> □	GU10 1x50W	€ 310,00	

IP20	Flicker < 20%	CE	▽	MC-E=3
220-240V	9,5W	CRI>90		
<b>3P06.K</b> ■ S. □	dim. IGBT - TRIAC	€ 320,00		
■ Led color	Nominal lm	Beam spread		
2 = 2700K	710	24°		
3 = 3000K	760			

□ Frame - Struttura CUP - Rosone

02 ● Black - Nero Black - Nero

06 ○ White - Bianco White - Bianco

Black power supply cable.

Cavo di alimentazione, nero.

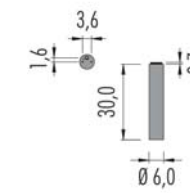
**Pop 07** Ø 6,0 Mono-color

IP20		CE	▽
220-240V			
<b>3P07.210</b> □	GU10 1x50W	€ 145,00	

IP20	Flicker < 20%	CE	▽	MC-E=3
220-240V	<b>9,5W</b>	CRI>90		
<b>3P07.K</b> ■ S. □	dim. IGBT - TRIAC	€ 180,00		
■ Led color	Nominal lm	Beam spread		
2 = 2700K	710	24°		
3 = 3000K	760			

□ Frame - Struttura

02 ● Black - Nero

06 ○ White - Bianco

(m-M) = min. Led unit - Max Led unit. Led and Emergency unit, warranty only when used together with driver bought from Oty srl.

(m-M) = gestione minima e massima delle unità Led. I Led e le unità di emergenza, sono coperti da garanzia solo se utilizzati in abbinamento con i driver forniti dalla Oty srl.

## Pop 06 Ø 6,0 Bi-color

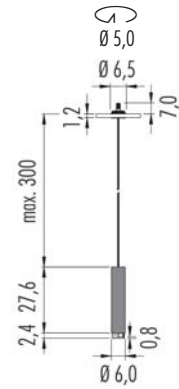

IP20	ARC	Flicker < 20%	CE	▽	MC-E=3
220-240V		9,5W CRI>90	dim.	IGBT	TRIAC
3P06A.K	S.KS		€	380,00	
3P06A.K	S.WS		€	380,00	
3P06A.K	S.BS		€	400,00	
3P06A.K	S.GS		€	400,00	
3P06A.K	S.PS		€	400,00	
3P06A.K	S.RS		€	400,00	

Led color	Nominal lm	Beam spread
2 = 2700K	710	24°
3 = 3000K	760	

ARC canopy - rosone: White - Bianco  
Wire/Cava: Brass - Ottone

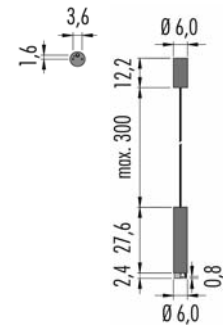

IP20	CUP	Flicker < 20%	CE	▽	MC-E=3
220-240V		9,5W CRI>90	dim.	IGBT	TRIAC
3P06C.K	S.KS		€	400,00	
3P06C.K	S.WS		€	400,00	
3P06C.K	S.BS		€	420,00	
3P06C.K	S.GS		€	420,00	
3P06C.K	S.PS		€	420,00	
3P06C.K	S.RS		€	420,00	

Led color	Nominal lm	Beam spread
2 = 2700K	710	24°
3 = 3000K	760	

CUP canopy - rosone: see table details - vedere tabella  
Wire/Cava: Brass - Ottone

Up	Down	CUP
KS	Black/Brass - Nero/Ottone	Black - Nero
WS	White/Brass - Bianco/Ottone	White - Bianco
BS	Blue/Brass - Blu/Ottone	Blue - Blu
GS	Green/Brass - Verde/Ottone	Green - Verde
PS	Rose/Brass - Rosa/Ottone	Roses - Rosa
RS	Red/Brass - Rosso/Ottone	Red - Rosso

## Pop 07 Ø 6,0 Bi-color



IP20	Flicker < 20%	CE	▽	MC-E=3
220-240V	9,5W CRI>90	dim.	IGBT	TRIAC
3P07.K	S.KS		€	200,00
3P07.K	S.WS		€	200,00
3P07.K	S.BS		€	220,00
3P07.K	S.GS		€	220,00
3P07.K	S.PS		€	220,00
3P07.K	S.RS		€	220,00

Led color	Nominal lm	Beam spread
2 = 2700K	710	24°
3 = 3000K	760	

Up	Down
KS	Black/Brass - Nero/Ottone
WS	White/Brass - Bianco/Ottone
BS	Blue/Brass - Blu/Ottone
GS	Green/Brass - Verde/Ottone
PS	Rose/Brass - Rosa/Ottone
RS	Red/Brass - Rosso/Ottone

## Pop X7 Ø 11,2

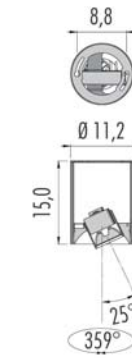

IP20	CE	▽
220V ÷ 240V		
3PX7.211.□	G10 led	€ 230,00
4PX7.211.□	G10 led	€ 240,00

With honeycomb - Con frangiluce

IP40	CE	▽	MC-E=3
220-240V	9,5W	CRI>90	dim.
3PX7.K	□		€ 250,00
4PX7.K	□		€ 260,00

With honeycomb - Con frangiluce

Led color	Nominal lm	Beam spread
2 = 2700K	834	M = 36°
3 = 3000K	877	S = 24°

Frame - Struttura	
02	Black - Nero
06	White - Bianco

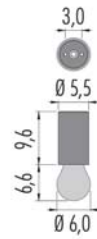
**Pop 07 small Bulb** ceiling - plafone

IP20	Ⓢ	CE	▽
220V ÷ 240V	e27 4W	CRI>80	
<b>3P07.A2L</b>	□	dim. IGBT - TRIAC	€ 105,00
■ Led color	Nominal lm	▲ Beam spread	
2700K	470	360°	

□	Frame - struttura		Bulb - lampadina
02	Black - Nero	● ○	Transparent - Trasparente
06	White - Bianco	○ ○	Transparent - Trasparente

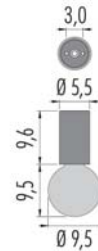
**Pop 07 big Bulb** ceiling - plafone

IP20	Ⓢ	CE	▽
220V ÷ 240V	e27 4W	CRI>80	
<b>3P07.B2L</b>	□	dim. IGBT - TRIAC	€ 115,00
■ Led color	Nominal lm	▲ Beam spread	
2700K	470	360°	

□	Frame - struttura		Bulb - lampadina
02	Black - Nero	● ○	Transparent - Trasparente
06	White - Bianco	○ ○	Transparent - Trasparente

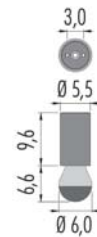
**Pop 07 small Bulb** wall - parete

IP20	Ⓢ	CE	▽
220V ÷ 240V	e27 7W	CRI>80	
<b>3P07.A2L</b>	□	dim. IGBT - TRIAC	€ 120,00
■ Led color	Nominal lm	▲ Beam spread	
2700K	806	180°	

□	Frame - struttura		Bulb - lampadina
02M	Black - Nero	● ○	Mirror Chrome - specchiata cromo
06M	White - Bianco	○ ○	Mirror Chrome - specchiata cromo

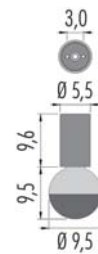
**Pop 07 big Bulb** wall - parete

IP20	Ⓢ	CE	▽
220V ÷ 240V	e27 7W	CRI>80	
<b>3P07.B2L</b>	□	dim. IGBT - TRIAC	€ 130,00
■ Led color	Nominal lm	▲ Beam spread	
2700K	806	180°	

□	Frame - struttura		Bulb - lampadina
02M	Black - Nero	● ○	Mirror Chrome - specchiata cromo
06M	White - Bianco	○ ○	Mirror Chrome - specchiata cromo

**Pop Ring pull** Ø 12,5 with trim

For plasterboard. Per cartongesso

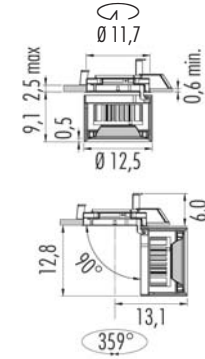

IP20	Ⓢ	MC-E=3	CE	▽	Ⓢ
500 m/A - 600 m/A			CRI>90		
<b>3PR1P.6</b>	■ ▲ □		€ 345,00		

Ⓢ (m-M)	LED 12,5W	350m/A
3KIT.350.1L (1-1)	on/off	€ 21,00
3KIT.351.40 (1-3)	DALI - Push - 1...10V	€ 125,00
3KIT.352.15 (1-1)	DALI	€ 67,00
3KIT.353.15 (1-1)	Push - 1...10V	€ 62,00
3KIT.354.18 (1-1)	IGBT - TRIAC	€ 32,00

■ Led color	Nominal lm	▲ Beam spread
2 = 2700K	1477	L = 60°
3 = 3000K	1565	S = 24°
4 = 4000K	1635	T = 12°

Ⓢ (m-M)	LED 18,4W	500m/A
3KIT.500.1L (1-1)	on/off	€ 21,00
3KIT.501.50 (1-2)	DALI - Push - 1...10V	€ 125,00
3KIT.502.20 (1-1)	DALI	€ 67,00
3KIT.503.20 (1-1)	Push - 1...10V	€ 62,00
3KIT.504.20 (1-1)	IGBT - TRIAC	€ 32,00

■ Led color	Nominal lm	▲ Beam spread
2 = 2700K	2020	L = 60°
3 = 3000K	2140	S = 24°
4 = 4000K	2236	T = 12°

Ⓢ (m-M)	LED 23W	600m/A
3KIT.600.1L (1-1)	on/off	€ 30,00
3KIT.601.50 (1-1)	DALI - Push - 1...10V	€ 125,00

■ Led color	Nominal lm	▲ Beam spread
2 = 2700K	2228	L = 60°
3 = 3000K	2357	S = 24°
4 = 4000K	2455	T = 12°

Emergency unit: (inverter + battery. Driver not included)

3KIT.900.01 (1-1)	1:00 hour	€ 110,00
3KIT.900.03 (1-1)	3:00 hours	€ 145,00

**Pop 07 pull** Ø 12,5

ceiling - plafone

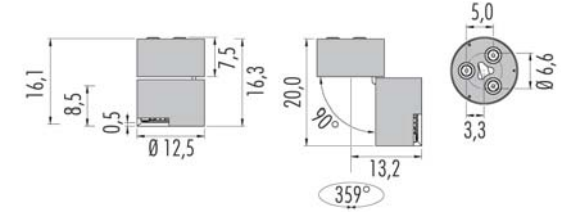

IP20	Ⓢ	CE	▽	MC-E=3
220-240V	18,4W	CRI>90		
<b>3P07P .5</b>	■ ▲ □	IGBT Triac	€ 480,00	
<b>3P07PA5</b>	■ ▲ □	DALI	€ 550,00	
<b>3P07PG5</b>	■ ▲ □	Push - 1...10V	€ 550,00	

■ Led color	Nominal lm	▲ Beam spread
2 = 2700K	2176	L = 60°
3 = 3000K	2301	S = 24°
4 = 4000K	2400	T = 12°

(m-M) = min. Led unit - Max Led unit. Led and Emergency unit, warranty only when used together with driver bought from Oty srl.

(m-M) = gestione minima e massima delle unità Led. I Led e le unità di emergenza, sono coperti da garanzia solo se utilizzati in abbinamento con i driver forniti dalla Oty srl.

**Pop 10** trimless **ROS**

For plasterboard. Per cartongesso

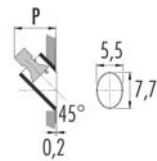

Code		P
3P10.211.□	GU10 Led	9,2
3P10.220.□	GU5.3	8,4
3P10.x1 ■ S.□	200m/A led	8,5

IP20		CE	▽	□
220V ÷ 240V				
3P10.211.□	GU10 led	€	100,00	

IP20		CE	▽	⊕
12V				
3P10.220.□	GU5.3 max 50W	€	100,00	
3KIT.201.050	max 50VA	€	35,00	

Dimmable gear: IGBT

IP20		CE	▽	⊕
220-240V	LED 3W CRI>95 Driver included			
3P10.01 ■ S.□	ON/OFF	€	150,00	
3P10.E1 ■ S.□	DALI - Push	€	170,00	
3P10.G1 ■ S.□	0...10V	€	160,00	

	Led color	Nominal lm	▲ Beam spread
2	2700K	396	24°
3	3000K	410	

Housing for plasterboard - Cassaforma cartongesso

● 1Z00.070.01	€	90,00
---------------	---	-------

□ Frame - Struttura

02 ● Black - Nero

06 ○ White - Bianco

(m-M) = min. Led unit - Max Led unit. Led and Emergency unit, warranty only when used together with driver bought from Oty srl.

**Pop P12/D** Ø 3,0

wall/ceiling - parete/plafone

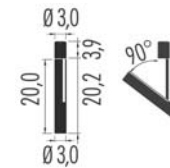

IP20		CE	▽	⊕
250m/A	LED 10W CRI>95			
3P12D.2 ■ S.□		€	200,00	
4P12D.2 ■ S.□		€	210,00	

With honeycomb - Con frangiluce

	Led color	Nominal lm	▲ Beam spread
2	2700K	989	24°
3	3000K	1061	
4	4000K	1151	

© (m-M) Driver remote installation - in remoto

3KIT.250.1L (1-1)	on/off	€	21,00
3KIT.251.2B (1-3)	DALI - Push - 1...10V	€	125,00
3KIT.252.12 (1-1)	DALI	€	67,00
3KIT.253.13 (1-1)	Push - 1...10V	€	62,00
3KIT.254.12 (1-1)	IGBT - TRIAC	€	32,00

□ Frame - Struttura

02 ● Black - Nero

06 ○ White - Bianco

(m-M) = gestione minima e massima delle unità Led. I Led e le unità di emergenza, sono coperti da garanzia solo se utilizzati in abbinamento con i driver forniti dalla Oty srl.



**Pop P12** Ø 3,0 trimless

For plasterboard and brickwork. Per cartongesso e laterizio

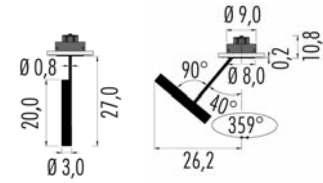

IP20	CE	V	Ⓜ
250m/A	<b>LED 10W</b>	CRI>95	
3P12.2	S. □	€ 270,00	
4P12.2	S. □	€ 280,00	
With honeycomb - Con frangiluce			
■ Led color	Nominal lm	▲ Beam spread	
2 = 2700K	989	24°	
3 = 3000K	1061		
4 = 4000K	1151		

© (m-M)	Driver		
3KIT.250.1L (1-1)	on/off	€ 21,00	
3KIT.251.28 (1-3)	DALI - Push - 1...10V remote installation - in remoto	€ 125,00	
3KIT.252.12 (1-1)	DALI	€ 67,00	
3KIT.253.13 (1-1)	Push - 1...10V	€ 62,00	
3KIT.254.12 (1-1)	IGBT - TRIAC	€ 32,00	

Emergency unit: (inverter + battery. Driver not included)

3KIT.900.01 (1-1)	1:00 hour	€ 110,00
3KIT.900.03 (1-1)	3:00 hours	€ 145,00

Housing for plasterboard - Cassaforma cartongesso ↷ Ø 9,5cm

- 1Z00.080.01 € 55,00

Housing for brickwork - Cassaforma laterizio

- 1M00.080.01 € 125,00

□ Frame - Struttura

- 02 ● Black - Nero
- 06 ○ White - Bianco

**Pop P12/T** Ø 3,0 with trim

For plasterboard. Per cartongesso

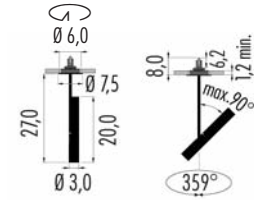

IP20	CE	V	Ⓜ
250m/A	<b>LED 10W</b>	CRI>95	
3P12T.2	S. □	€ 250,00	
4P12T.2	S. □	€ 260,00	
With honeycomb - Con frangiluce			
■ Led color	Nominal lm	▲ Beam spread	
2 = 2700K	989	24°	
3 = 3000K	1061		
4 = 4000K	1151		

© (m-M)	Driver		
3KIT.250.1L (1-1)	on/off	€ 21,00	
3KIT.251.28 (1-3)	DALI - Push - 1...10V remote installation - in remoto	€ 125,00	
3KIT.252.12 (1-1)	DALI	€ 67,00	
3KIT.253.13 (1-1)	Push - 1...10V	€ 62,00	
3KIT.254.12 (1-1)	IGBT - TRIAC	€ 32,00	

Emergency unit: (inverter + battery. Driver not included)

3KIT.900.01 (1-1)	1:00 hour	€ 110,00
3KIT.900.03 (1-1)	3:00 hours	€ 145,00

□ Frame - Struttura

- 02 ● Black - Nero
- 06 ○ White - Bianco

(m-M) = min. Led unit - Max Led unit. Led and Emergency unit, warranty only when used together with driver bought from Oty srl.

**Pop P12/L** Ø 3,0 trimless

For plasterboard. Per cartongesso

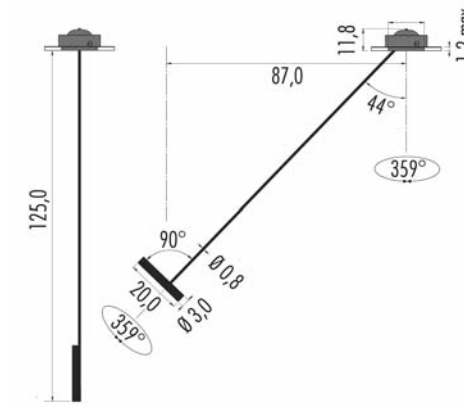

IP20	CE	V	Ⓜ
250m/A	<b>LED 10W</b>	CRI>95	
3P12L.2	S. □	€ 450,00	
4P12L.2	S. □	€ 460,00	
With honeycomb - Con frangiluce			
■ Led color	Nominal lm	▲ Beam spread	
2 = 2700K	989	24°	
3 = 3000K	1061		
4 = 4000K	1151		

© (m-M)	Driver		
3KIT.250.1L (1-1)	on/off	€ 21,00	
3KIT.251.28 (1-3)	DALI - Push - 1...10V remote installation - in remoto	€ 125,00	
3KIT.252.12 (1-1)	DALI	€ 67,00	
3KIT.253.13 (1-1)	Push - 1...10V	€ 62,00	
3KIT.254.12 (1-1)	IGBT - TRIAC	€ 32,00	

Emergency unit: (inverter + battery. Driver not included)

3KIT.900.01 (1-1)	1:00 hour	€ 110,00
3KIT.900.03 (1-1)	3:00 hours	€ 145,00

Housing for plasterboard - Cassaforma cartongesso ↷ Ø 12,5cm

- 1W00.125.01 € 165,00

Housing for plasterboard with 1,2cm max thickness  
Cassaforma per cartongesso con spessore max di 1,2cm

(m-M) = gestione minima e massima delle unità Led. I Led e le unità di emergenza, sono coperti da garanzia solo se utilizzati in abbinamento con i driver forniti dalla Oty srl.

**Pop P12/K** Ø 3,0 ROS

ceiling - plafone

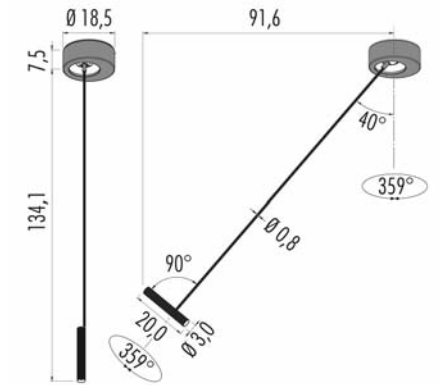

IP20	CE	V	Ⓜ
220-240V	<b>LED 10W</b>	CRI>95	
3P12K.2	S. □ dimm. IGBT - TRIAC	€ 750,00	
4P12K.2	S. □ dimm. IGBT - TRIAC	€ 760,00	
With honeycomb - Con frangiluce			
3P12KA2	S. □ DALI	€ 800,00	
4P12KA2	S. □ DALI	€ 810,00	
With honeycomb - Con frangiluce			
3P12KG2	S. □ Push - 1...10V	€ 800,00	
4P12KG2	S. □ Push - 1...10V	€ 810,00	
With honeycomb - Con frangiluce			
■ Led color	Nominal lm	▲ Beam spread	
2 = 2700K	989	24°	
3 = 3000K	1061		
4 = 4000K	1151		

3KIT.250.1L (1-1)	on/off	€ 21,00
3KIT.251.28 (1-3)	DALI - Push - 1...10V remote installation - in remoto	€ 125,00
3KIT.252.12 (1-1)	DALI	€ 67,00
3KIT.253.13 (1-1)	Push - 1...10V	€ 62,00
3KIT.254.12 (1-1)	IGBT - TRIAC	€ 32,00

□ Frame - Struttura

- 02 ● Black - Nero
- 06 ○ White - Bianco

**Pop P12 Ø 7,0 trimless**

For plasterboard and brickwork. Per cartongesso e laterizio

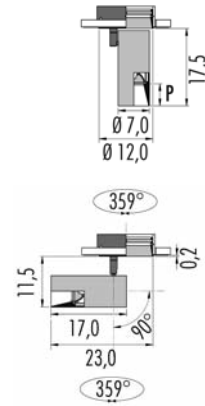

IP20					
220V ÷ 240V					
<b>3P12.210.</b>		<b>GU10</b> max 50W	€	<b>250,00</b>	

IP20					
12V					
<b>3P12.220.</b>		<b>GU5.3</b> max 50W	€	<b>250,00</b>	
<b>3KIT.201.050</b>		max 50VA	€	<b>35,00</b>	
Dimmable gear: IGBT					

IP20					
350m/A					
<b>3P12.3</b>		<b>LED 11W</b>	€	<b>300,00</b>	
<b>4P12.3</b>		<b>LED 11W</b>	€	<b>310,00</b>	

With honeycomb - Con frangiluce

Led color	Nominal lm	Beam spread
2 = 2700K	1195	M = 38°
3 = 3000K	1257	S = 22°
4 = 4000K	1313	T = 10°

(m-M)	Driver	Price
<b>3KIT.350.1L</b> (1-1)	on/off	€ <b>21,00</b>
<b>3KIT.351.40</b> (1-3)	DALI - Push - 1...10V	€ <b>125,00</b>
<b>3KIT.352.15</b> (1-1)	DALI	€ <b>67,00</b>
<b>3KIT.353.15</b> (1-1)	Push - 1...10V	€ <b>62,00</b>
<b>3KIT.354.18</b> (1-1)	IGBT - TRIAC	€ <b>32,00</b>

Emergency unit: (inverter + battery. Driver not included)

<b>3KIT.900.01</b> (1-1)	1:00 hour	€ <b>110,00</b>
<b>3KIT.900.03</b> (1-1)	3:00 hours	€ <b>145,00</b>

Housing for plasterboard - Cassaforma cartongesso Ø 14,0cm

● <b>1Z00.120.01</b>	Single	€ <b>60,00</b>
●● <b>1Z00.120.2L</b>	Double	€ <b>105,00</b>

Housing for brickwork - Cassaforma laterizio

● <b>1M00.120.01</b>	€ <b>140,00</b>
----------------------	-----------------

**Pop P12 Ø 12,5 trimless**

For plasterboard and brickwork. Per cartongesso e laterizio

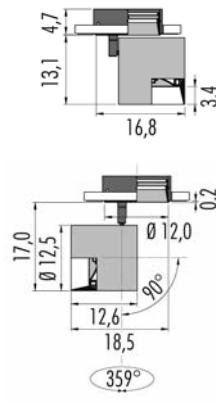

IP40					
350 - 500 - 700 m/A					
<b>3P12.6</b>		<b>LED 12,5W</b>	€	<b>320,00</b>	

(m-M)	LED 12,5W	350m/A
<b>3KIT.350.1L</b> (1-1)	on/off	€ <b>21,00</b>
<b>3KIT.351.40</b> (1-3)	DALI - Push - 1...10V	€ <b>125,00</b>
<b>3KIT.352.15</b> (1-1)	DALI	€ <b>67,00</b>
<b>3KIT.353.15</b> (1-1)	Push - 1...10V	€ <b>62,00</b>
<b>3KIT.354.18</b> (1-1)	IGBT - TRIAC	€ <b>32,00</b>

Led color	Nominal lm	Beam spread
2 = 2700K	1477	L = 60°
3 = 3000K	1565	S = 24°
4 = 4000K	1635	T = 12°

(m-M)	LED 18,4W	500m/A
<b>3KIT.500.1L</b> (1-1)	on/off	€ <b>21,00</b>
<b>3KIT.501.50</b> (1-2)	DALI - Push - 1...10V	€ <b>125,00</b>
<b>3KIT.502.20</b> (1-1)	DALI	€ <b>67,00</b>
<b>3KIT.503.20</b> (1-1)	Push - 1...10V	€ <b>62,00</b>
<b>3KIT.504.20</b> (1-1)	IGBT - TRIAC	€ <b>32,00</b>

Led color	Nominal lm	Beam spread
2 = 2700K	2020	L = 60°
3 = 3000K	2140	S = 24°
4 = 4000K	2236	T = 12°

(m-M)	LED 27W	700m/A
<b>3KIT.700.1L</b> (1-1)	on/off	€ <b>30,00</b>
<b>3KIT.701.50</b> (1-1)	DALI - Push - 1...10V	€ <b>125,00</b>

Led color	Nominal lm	Beam spread
2 = 2700K	2683	L = 60°
3 = 3000K	2842	S = 24°
4 = 4000K	2963	T = 12°

 Frame - Struttura

02 ●	Black - Nero
06 ○	White - Bianco

**Pop 12 Ring Ø 3,0 with trim**

For plasterboard. Per cartongesso

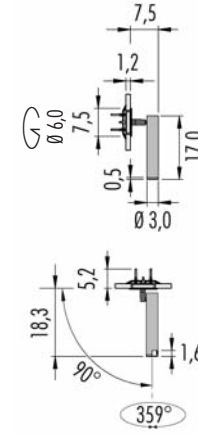

IP20					
500 m/A					
<b>3PR12.2</b>		<b>6W</b>	€	<b>310,00</b>	
<b>4PR12.2</b>		<b>6W</b>	€	<b>320,00</b>	

With honeycomb - Con frangiluce

Led color	Nominal lm	Beam spread
2 = 2700K	528	24°
3 = 3000K	552	
4 = 4000K	594	

(m-M)	Driver	Price
<b>3KIT.500.15</b> (1-1)	on/off	€ <b>30,00</b>
<b>3KIT.501.50</b> (1-7)	DALI - Push - 1...10V	€ <b>125,00</b>
<b>3KIT.502.20</b> (1-3)	DALI	€ <b>67,00</b>
<b>3KIT.503.20</b> (1-3)	Push - 1...10	€ <b>62,00</b>
<b>3KIT.504.10</b> (1-1)	IGBT - TRIAC	€ <b>32,00</b>

 Frame - Struttura

02 ●	Black - Nero
06 ○	White - Bianco

**Pop 12 Cup Ø 3,0**

wall/ceiling - parete/plafone

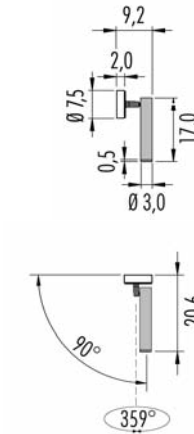

IP20					
500 m/A					
<b>3PC12.2</b>		<b>6W</b>	€	<b>310,00</b>	
<b>4PC12.2</b>		<b>6W</b>	€	<b>320,00</b>	

With honeycomb - Con frangiluce

Led color	Nominal lm	Beam spread
2 = 2700K	528	24°
3 = 3000K	552	
4 = 4000K	594	

(m-M)	Driver remote installation - in remoto	Price
<b>3KIT.500.15</b> (1-1)	on/off	€ <b>30,00</b>
<b>3KIT.501.50</b> (1-7)	DALI - Push - 1...10V	€ <b>125,00</b>
<b>3KIT.502.20</b> (1-3)	DALI	€ <b>67,00</b>
<b>3KIT.503.20</b> (1-3)	Push - 1...10	€ <b>62,00</b>
<b>3KIT.504.10</b> (1-1)	IGBT - TRIAC	€ <b>32,00</b>

 Frame - Struttura

02 ●	Black - Nero
06 ○	White - Bianco

**Pop 12/W Ø 3,0**

parete/plafone

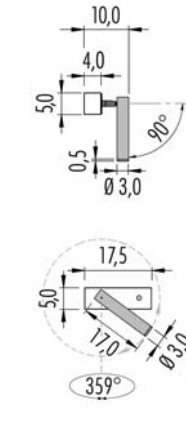

IP40					
220-240V					
<b>3P12W.P</b>		<b>3W</b>	€	<b>360,00</b>	
<b>3P12W.0</b>		<b>3W</b>	€	<b>340,00</b>	

Led color	Nominal lm	Beam spread
2 = 2700K	340	24°
3 = 3000K	380	

IP40					
220-240V					
<b>3P12W.D</b>		<b>6W</b>	€	<b>340,00</b>	

Led color	Nominal lm	Beam spread
2 = 2700K	637	24°
3 = 3000K	712	

 Frame - Struttura

02 ●	Black - Nero
06 ○	White - Bianco

**Pop 12 Ring Ø 6,0 with trim**

For plasterboard. Per cartongesso

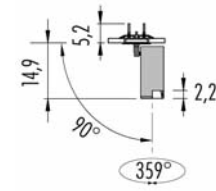
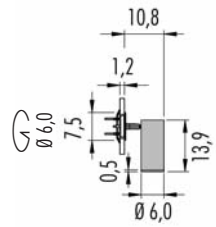

IP20	Flicker < 20%	CE	▽	□
220V ÷ 240V	<b>9,5W</b>	CRI>90		
<b>3PR12.K</b> ■▲□	dim IGBT - TRIAC	€	<b>300,00</b>	
<b>4PR12.K</b> ■▲□	dim IGBT - TRIAC	€	<b>310,00</b>	
With honeycomb. Con frangiluce				

Led color	Nominal lm	Beam spread
2 = 2700K	710	M = 36°
3 = 3000K	760	S = 24°

IP20	MC-E=3	CE	▽	◇
350m/A	<b>11W</b>	CRI>95		
<b>3PR12.3</b> ■▲□		€	<b>300,00</b>	
<b>4PR12.3</b> ■▲□		€	<b>310,00</b>	

With honeycomb, only for S (22°) and T (10°)  
Con frangiluce, solo per S (22°) e T (10°)

Led color	Nominal lm	Beam spread
2 = 2700K	1195	M = 38°
3 = 3000K	1257	S = 22°
4 = 4000K	1313	T = 10°

© (m-M)	Driver		
<b>3KIT.350.1L</b> (1-1)	on/off	€	<b>21,00</b>
<b>3KIT.351.40</b> (1-3)	DALI - Push - 1...10V	€	<b>125,00</b>
remote installation - in remoto			
<b>3KIT.352.15</b> (1-1)	DALI	€	<b>67,00</b>
<b>3KIT.353.15</b> (1-1)	Push - 1...10V	€	<b>62,00</b>
<b>3KIT.354.18</b> (1-1)	IGBT - TRIAC	€	<b>32,00</b>

□	Frame - Struttura
02 ●	Black - Nero
06 ○	White - Bianco

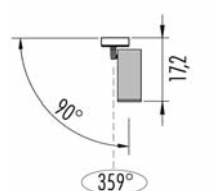
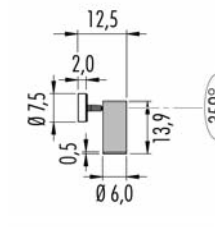
**Pop 12 Cup Ø 6,0 wall/ceiling - parete/plafone**

IP20	Flicker < 20%	CE	▽	□
220V ÷ 240V	<b>9,5W</b>	CRI>90		
<b>3PC12.K</b> ■▲□	dim IGBT - TRIAC	€	<b>300,00</b>	
<b>4PC12.K</b> ■▲□	dim IGBT - TRIAC	€	<b>310,00</b>	
With honeycomb. Con frangiluce				

Led color	Nominal lm	Beam spread
2 = 2700K	710	M = 36°
3 = 3000K	760	S = 24°

IP20	MC-E=3	CE	▽	◇
350m/A	<b>11W</b>	CRI>95		
<b>3PC12.3</b> ■▲□		€	<b>300,00</b>	
<b>4PC12.3</b> ■▲□		€	<b>310,00</b>	

With honeycomb, only for S (22°) and T (10°)  
Con frangiluce, solo per S (22°) e T (10°)

Led color	Nominal lm	Beam spread
2 = 2700K	1195	M = 38°
3 = 3000K	1257	S = 22°
4 = 4000K	1313	T = 10°

© (m-M)	Driver remote installation - in remoto		
<b>3KIT.350.1L</b> (1-1)	on/off	€	<b>21,00</b>
<b>3KIT.351.40</b> (1-3)	DALI - Push - 1...10V	€	<b>125,00</b>
<b>3KIT.352.15</b> (1-1)	DALI	€	<b>67,00</b>
<b>3KIT.353.15</b> (1-1)	Push - 1...10V	€	<b>62,00</b>
<b>3KIT.354.18</b> (1-1)	IGBT - TRIAC	€	<b>32,00</b>

□	Frame - Struttura
02 ●	Black - Nero
06 ○	White - Bianco

**Pop 12 Ring Ø 12,0 with trim**

For plasterboard. Per cartongesso

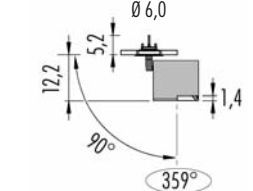
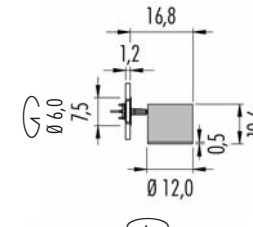

IP40	MC-E=3	CE	▽	◇
350 - 500 - 700 m/A		CRI>90		
<b>3PR12.6</b> ■▲□		€	<b>380,00</b>	

© (m-M)	LED 12,5W	350m/A		
<b>3KIT.350.1L</b> (1-1)	on/off	€	<b>21,00</b>	
<b>3KIT.351.40</b> (1-3)	DALI - Push - 1...10V	€	<b>125,00</b>	
remote installation - in remoto				
<b>3KIT.352.15</b> (1-1)	DALI	€	<b>67,00</b>	
<b>3KIT.353.15</b> (1-1)	Push - 1...10V	€	<b>62,00</b>	
<b>3KIT.354.18</b> (1-1)	IGBT - TRIAC	€	<b>32,00</b>	

Led color	Nominal lm	Beam spread
2 = 2700K	1578	L = 60°
3 = 3000K	1669	S = 24°
4 = 4000K	1740	T = 12°

© (m-M)	LED 18,4W	500m/A		
<b>3KIT.500.1L</b> (1-1)	on/off	€	<b>21,00</b>	
<b>3KIT.501.50</b> (1-2)	DALI - Push - 1...10V	€	<b>125,00</b>	
remote installation - in remoto				
<b>3KIT.502.20</b> (1-1)	DALI	€	<b>67,00</b>	
<b>3KIT.503.20</b> (1-1)	Push - 1...10V	€	<b>62,00</b>	
<b>3KIT.504.20</b> (1-1)	IGBT - TRIAC	€	<b>32,00</b>	

Led color	Nominal lm	Beam spread
2 = 2700K	2176	L = 60°
3 = 3000K	2301	S = 24°
4 = 4000K	2400	T = 12°

© (m-M)	LED 27W	700m/A		
<b>3KIT.700.1L</b> (1-1)	on/off	€	<b>30,00</b>	
<b>3KIT.701.50</b> (1-1)	DALI - Push - 1...10V	€	<b>125,00</b>	
remote installation - in remoto				

Led color	Nominal lm	Beam spread
2 = 2700K	2914	L = 60°
3 = 3000K	3081	S = 24°
4 = 4000K	3213	T = 12°

□	Frame - Struttura
02 ●	Black - Nero
06 ○	White - Bianco

**Pop 12 Cup Ø 12,0 wall/ceiling - parete/plafone**

For plasterboard. Per cartongesso

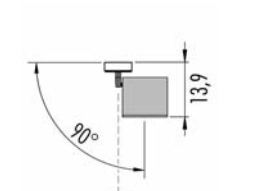
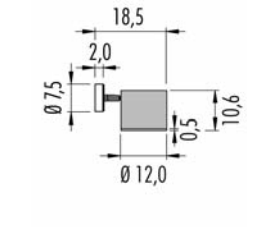

IP40	MC-E=3	CE	▽	◇
350 - 500 - 700 m/A		CRI>90		
<b>3PC12.6</b> ■▲□		€	<b>380,00</b>	

© (m-M)	LED 12,5W	350m/A		
Driver remote installation - in remoto:				
<b>3KIT.350.1L</b> (1-1)	on/off	€	<b>21,00</b>	
<b>3KIT.351.40</b> (1-3)	DALI - Push - 1...10V	€	<b>125,00</b>	
<b>3KIT.352.15</b> (1-1)	DALI	€	<b>67,00</b>	
<b>3KIT.353.15</b> (1-1)	Push - 1...10V	€	<b>62,00</b>	
<b>3KIT.354.18</b> (1-1)	IGBT - TRIAC	€	<b>32,00</b>	

Led color	Nominal lm	Beam spread
2 = 2700K	1578	L = 60°
3 = 3000K	1669	S = 24°
4 = 4000K	1740	T = 12°

© (m-M)	LED 18,4W	500m/A		
Driver remote installation - in remoto:				
<b>3KIT.500.1L</b> (1-1)	on/off	€	<b>21,00</b>	
<b>3KIT.501.50</b> (1-2)	DALI - Push - 1...10V	€	<b>125,00</b>	
<b>3KIT.502.20</b> (1-1)	DALI	€	<b>67,00</b>	
<b>3KIT.503.20</b> (1-1)	Push - 1...10V	€	<b>62,00</b>	
<b>3KIT.504.20</b> (1-1)	IGBT - TRIAC	€	<b>32,00</b>	

Led color	Nominal lm	Beam spread
2 = 2700K	2176	L = 60°
3 = 3000K	2301	S = 24°
4 = 4000K	2400	T = 12°

© (m-M)	LED 27W	700m/A		
Driver remote installation - in remoto:				
<b>3KIT.700.1L</b> (1-1)	on/off	€	<b>30,00</b>	
<b>3KIT.701.50</b> (1-1)	DALI - Push - 1...10V	€	<b>125,00</b>	

Led color	Nominal lm	Beam spread
2 = 2700K	2914	L = 60°
3 = 3000K	3081	S = 24°
4 = 4000K	3213	T = 12°

□	Frame - Struttura
02 ●	Black - Nero
06 ○	White - Bianco

## Polifemo PF1

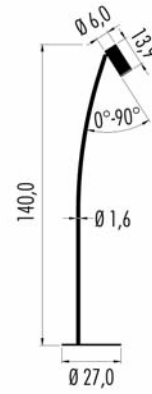

IP20	MC-E=3	CE	▽
100-240V	11W CRI>95	dimmable	
3PF1.3	S. □	€ 700,00	
4PF1.3	S. □	€ 710,00	
With honeycomb - Con frangiluce			
■ Led color	Nominal lm	Beam spread	
2 = 2700K	1195	22°	
3 = 3000K	1257		
4 = 4000K	1313		

## Pop 12 Polifemo PF3

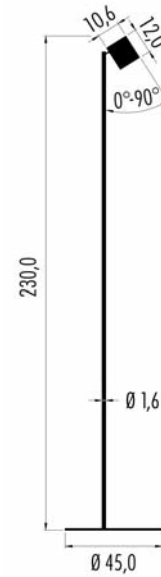

IP20	MC-E=3	CE	▽
100-240V	12,5W CRI>90	dimmable	
3PF3.4	□	€ 1.000,00	
■ Led color	Nominal lm	Beam spread	
2 = 2700K	1578	L = 60°	
3 = 3000K	1669	S = 24°	
4 = 4000K	1740		

□	Frame - Struttura	Ring - Anello
KC	● Black - Nero	● Copper Anodized - Rame anodizzato
KS	● Black - Nero	● Brass Anodized - Ottone anodizzato
WC	○ White - Bianco	● Copper Anodized - Rame anodizzato
WS	○ White - Bianco	● Brass Anodized - Ottone anodizzato

## Pop 13 Ø 7,0 wall/ceiling - parete/plafone

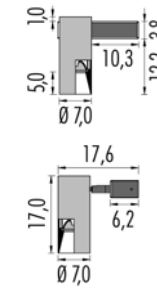

IP20	CE	▽	
220-240V	GU10 1x50W		
3P13.210	□	€ 310,00	
IP20	MC-E=3	CE	▽
220-240V	11W	CRI>95	
3P13.3	□ IGBT Triac	€ 410,00	
4P13.3	□ IGBT Triac	€ 420,00	
With honeycomb - Con frangiluce			
3P13A3	□ DALI	€ 450,00	
4P13A3	□ DALI	€ 460,00	
With honeycomb - Con frangiluce			
3P13G3	□ Push - 1...10V	€ 450,00	
4P13G3	□ Push - 1...10V	€ 460,00	
With honeycomb - Con frangiluce			
■ Led color	Nominal lm	▲ Beam spread	
2 = 2700K	1119	M = 38° (P=0,5)	
3 = 3000K	1257	S = 22° (P=5,0)	
4 = 4000K	1313	T = 10° (P=0,5)	

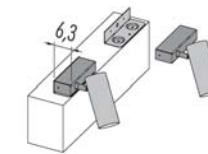

Installation kit on beams and horizontal surfaces  
Kit di montaggio su travi o piani orizzontali

1KIT.P136. □ € 25,00

□	Frame - Struttura
02	● Black - Nero
06	○ White - Bianco

## Pop 13 Ø 12,5 wall/ceiling - parete/plafone

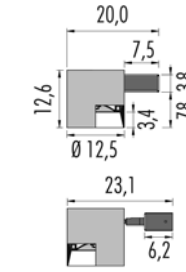

IP20	MC-E=3	CE	▽
220-240V	12,5W	CRI>90	
3P13.4	□ on/off	€ 450,00	
3P13A4	□ DALI	€ 490,00	
3P13G4	□ Push - 1...10V	€ 490,00	
■ Led color	Nominal lm	▲ Beam spread	
2 = 2700K	1477	L = 60°	
3 = 3000K	1565	S = 24°	
4 = 4000K	1635	T = 12°	
IP20	MC-E=3	CE	▽
220-240V	18,5W	CRI>90	
3P13.5	□ on/off	€ 450,00	
3P13A5	□ DALI	€ 490,00	
3P13G5	□ Push - 1...10V	€ 490,00	
■ Led color	Nominal lm	▲ Beam spread	
2 = 2700K	2020	L = 60°	
3 = 3000K	2140	S = 24°	
4 = 4000K	2236	T = 12°	
IP20	MC-E=3	CE	▽
220-240V	27W	CRI>90	
3P13.6	□ on/off	€ 450,00	
3P13E6	□ DALI - Push	€ 490,00	
3P13C6	□ 1...10V	€ 490,00	
■ Led color	Nominal lm	▲ Beam spread	
2 = 2700K	2683	L = 60°	
3 = 3000K	2842	S = 24°	
4 = 4000K	2963	T = 12°	

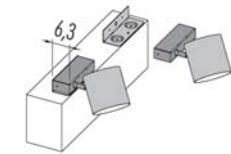

Installation kit on beams and horizontal surfaces  
Kit di montaggio su travi o piani orizzontali

1KIT.P136. □ € 25,00

Pop P15 Ø 3,0 X-Rail: magnet track system 48V  
X-Rail: sistema a binario magnetico 48V

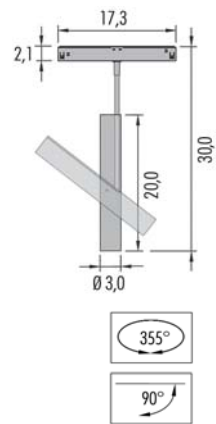

IP20	MC-E=3	CE	▽	⊕
48V	LED 8,0W	CRI>95		
3P15.02	□ on/off	€ 230,00		
4P15.02	□ on/off	€ 240,00		
<i>With honeycomb - Con frangiluce</i>				
3P15.G2	□ dimmable	€ 270,00		
4P15.G2	□ dimmable	€ 280,00		
<i>With honeycomb - Con frangiluce</i>				
■ Led color	Nominal lm	▲ Beam spread		
2 = 2700K	715	24°		
3 = 3000K	767			
4 = 4000K	832			

□	Frame - Struttura
02 ●	Black - Nero
06 ●	White - Bianco

Attention, before ordering the item:

- 1- Choose the appropriate 48V devices (100-150-240W), paying attention to the drop voltage table;
- 2- If you need to dim the light, choose the two options:
  - a. by a Master DALI (item not supplied by Oty);
  - b. by our dimming device 3KIT.607.DIM.
- 3- All our items are "Noise Free" dimming if installed as explained on the "devices installation scheme".

Attenzione, prima di ordinare l'articolo:

- 1 - scegliere il trasformatore 48V adeguato (100-150-240W) prestando attenzione alla tabella di caduta tensione;
- 2 - per dimmerare la luce, scegliere una delle due opzioni:
  - a. tramite Master Dali (articolo non fornito da Oty srl);
  - b. tramite il nostro dispositivo 3KIT.607.DIM
- 3 - Tutti i ns. articoli sono dimmerabili "Noise Free" se installati come da schema di cablaggio.

Magnet system  
Sistema magnetico

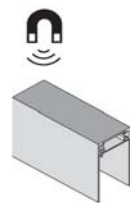

Bidirectional installation  
Installazione bidirezionale

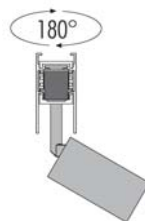

Click&Safety Lock  
Fissaggio meccanico di sicurezza

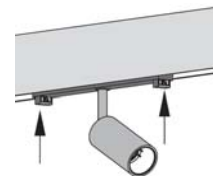

Adjustable  
Orientabile

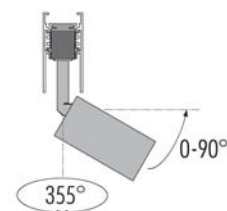

WiFi Technology by App  
Tecnologia WiFi tramite App

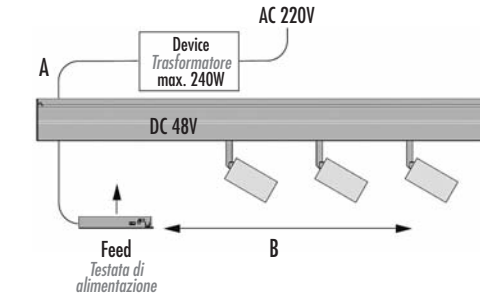

- (A) Distance Device/Feed Unit  
(A) Distanza dal trasformatore alla testata di alimentazione.  
(B) Distance Feed Unit/Spot  
(B) Distanza dalla testata di alimentazione all'ultimo articolo.

Drop voltage table - Tabella caduta di tensione

Device	(A)	5 mt.	10 mt.	20 mt.	30 mt.
100W	(B)	50 mt.	50 mt.	30 mt.	10 mt.
150W	(B)	20 mt.	15 mt.	5 mt.	—
240W	(B)	15 mt.	10 mt.	—	—

Technical characteristics of the devices for 48V Track - Caratteristiche tecniche dei dispositivi per binario 48V

Code	W	Size (mm)	CV	Connectable fixtures	Max distance	Cable section	Tech. Info
3KIT.048.100	100	199x63x36	48V	Max: 70W	See chart here above	2.5mm <sup>2</sup>	100-305V 47-63Hz € 95,00
3KIT.048.150	150	219x63x36	48V	Max: 105W	See chart here above	2.5mm <sup>2</sup>	100-305V 47-63Hz € 120,00
3KIT.048.245	240	244x71x38	48V	Max: 150W	See chart here above	2.5mm <sup>2</sup>	100-305V 47-63Hz € 140,00

Led warranty ONLY when used together with devices bought from Oty srl

I Led sono coperti da garanzia solo se utilizzati in abbinamento con i dispositivi acquistabili dalla Oty srl.

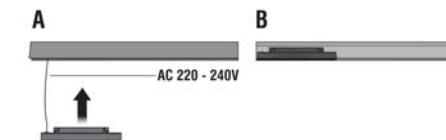

Technical characteristics of the devices for 48V Track  
Caratteristiche tecniche dei dispositivi per binario 48V

Code	W	Size	CV	Connectable fixtures
3KIT.048.060	60	242mm	48V	Max: 48W € 260,00
Tech. Info	120-277V		47-63Hz	

WiFi device "Noise Free" to dim the light -  
Dispositivo dimmerabile WiFi "Noise Free"

Code	Size (mm)	Price
3KIT.607.DIM	80x40x25mm	€ 150,00

It works by WiFi with smart phone, Google Assistant or Amazon Alexa. App on request.

Il dispositivo lavora in WiFi tramite smartphone, con Assistente Google o Alexa Amazon. App su richiesta.



Pop Host Ø 32,0 Mono-color

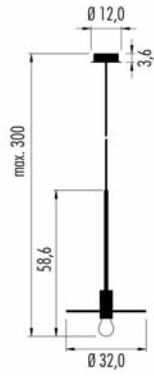

IP20	Ⓛ	CE	▽
220-240V	e27 7W	CRI>80	
<b>3H32C.12L.06</b>	dim. IGBT - Triac	€ 390,00	
Led color	Nominal lm	Beam spread	
2700K	806	180°	

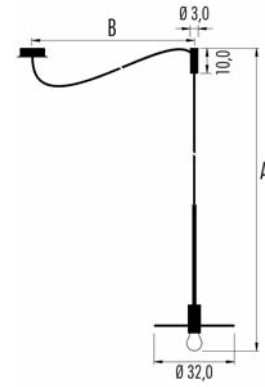

IP20	Ⓛ	A+B=390cm	CE	▽
220-240V	e27 7W	CRI>80		
<b>3H32D.12L.06</b>	dim. IGBT - Triac	€ 450,00		
Led color	Nominal lm	Beam spread		
2700K	806	180°		

Pop Host Ø 80,0 Mono-color

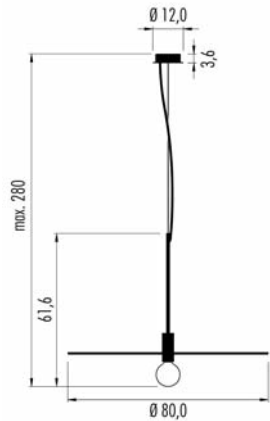

IP20	Ⓛ	CE	▽
220-240V	e27 7W	CRI>80	
<b>3H80C.12L.06</b>	dim. IGBT - Triac	€ 700,00	
Led color	Nominal lm	Beam spread	
2700K	806	180°	

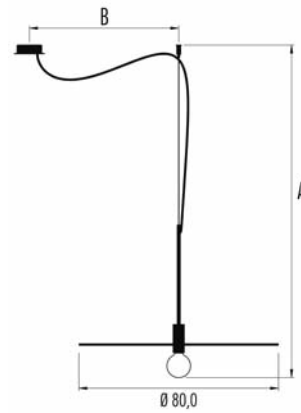

IP20	Ⓛ	A+B=390cm	CE	▽
220-240V	e27 7W	CRI>80		
<b>3H80D.12L.06</b>	dim. IGBT - Triac	€ 780,00		
Led color	Nominal lm	Beam spread		
2700K	806	180°		

Frame/Struttura	Wire/Cavo	Bulb/Lampadina
White - Bianco	White - Bianco	Mirror chrome - Specchiata cromo

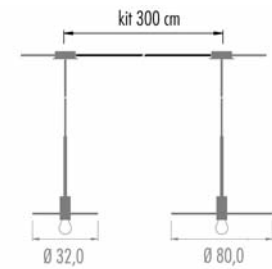

Kit Cable for Host composition: H32C - H80C		
1KIT.300.06	White	€ 36,00

Pop Host Ø 32,0 Bi-color

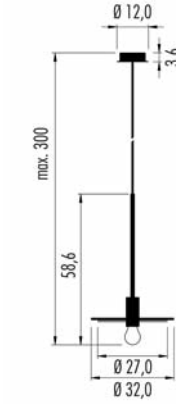

IP20	Ⓛ	CE	▽
220-240V	e27 7W	CRI>80	
<b>3H32C.12L.□</b>	dim. IGBT - Triac	€ 620,00	
Led color	Nominal lm	Beam spread	
2700K	806	180°	

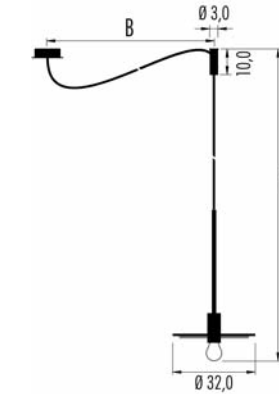

IP20	Ⓛ	A+B=390cm	CE	▽
220-240V	e27 7W	CRI>80		
<b>3H32D.12L.□</b>	dim. IGBT - Triac	€ 690,00		
Led color	Nominal lm	Beam spread		
2700K	806	180°		

Pop Host Ø 80,0 Bi-color

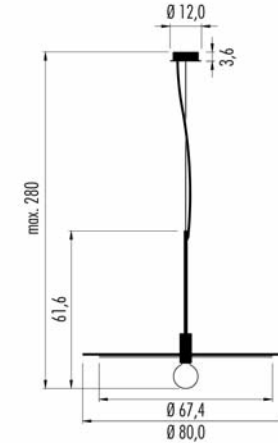

IP20	Ⓛ	CE	▽
220-240V	e27 7W	CRI>80	
<b>3H80C.12L.□</b>	dim. IGBT - Triac	€ 1.450,00	
Led color	Nominal lm	Beam spread	
2700K	806	180°	

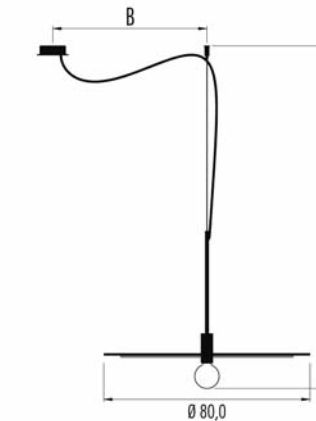

IP20	Ⓛ	A+B=390cm	CE	▽
220-240V	e27 7W	CRI>80		
<b>3H80D.12L.□</b>	dim. IGBT - Triac	€ 1.500,00		
Led color	Nominal lm	Beam spread		
2700K	806	180°		

□	Up	Down	Diffuser color - Colore diffusore	CUP - Rosone
KS	●	●	Black/Brass - Nero/Ottone	Black - Nero
WS	○	●	White/Brass - Bianco/Ottone	White - Bianco
BS	●	●	Blue/Brass - Blu/Ottone	Blue - Blu
GS	●	●	Green/Brass - Verde/Ottone	Green - Verde
PS	●	●	Rose/Brass - Rosa/Ottone	Rose - Rosa
RS	●	●	Red/Brass - Rosso/Ottone	Red - Rosso

Wire/Cavo	Bulb/Lampadina
Brass - Ottone	Mirror Brass - Specchiata ottone

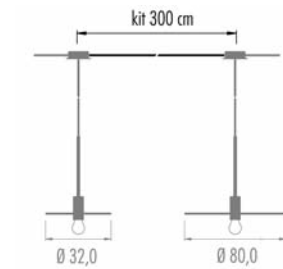

Kit Cable for Host composition: H32C - H80C		
1KIT.300.S	Brass - Ottone	€ 90,00

**Pop Host W**  $\varnothing 32,0/\varnothing 80,0$  Bi-color  
wall/ceiling - parete/plafone

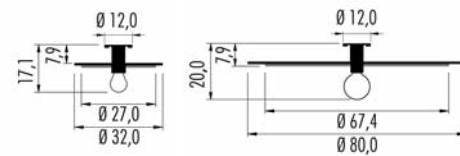

IP20	CE	∇
220-240V	e27 7W CRI>80	IGBT - Triac
<b>3H32W.12L.</b> □	$\varnothing 32\text{cm}$	€ 450,00
<b>3H80W.12L.</b> □	$\varnothing 80\text{cm}$	€ 1.250,00
Led color 2700K	Nominal lm 806	Beam spread 180°

□	Up	Down	Diffuser color - Diffusore
KS	●	●	Black/Brass - Nero/Ottone
WS	○	●	White/Brass - Bianco/Ottone
BS	●	●	Blue/Brass - Blu/Ottone
GS	●	●	Green/Brass - Verde/Ottone
PS	●	●	Rose/Brass - Rosa/Ottone
RS	●	●	Red/Brass - Rosso/Ottone

Wire/Cavo  
Brass - Ottone

Bulb/Lampadina  
Mirror Brass - Specchiata ottone

**Pop Host L/M - T/N** Bi-color

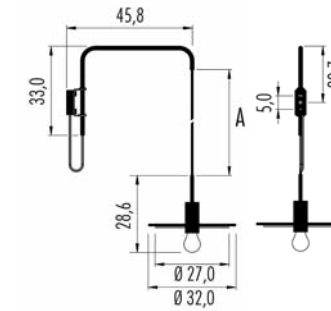

IP20	A= max. 140cm	CE	∇
220-240V	e27 7W	CRI>80	
<b>3H32N.12L.</b> □	dim. IGBT - Triac	€ 860,00	
Led color 2700K	Nominal lm 806	Beam spread 180°	

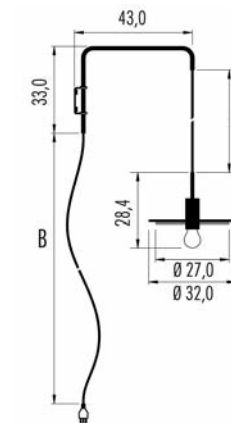

IP20	A+B=360cm	CE	∇
220-240V	e27 7W	CRI>80	
<b>3H32T.12L.</b> □	dim. IGBT - Triac	€ 860,00	
Led color 2700K	Nominal lm 806	Beam spread 180°	

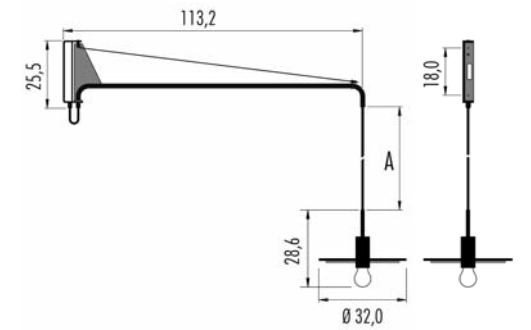

IP20	A= max. 130cm	CE	∇
220-240V	e27 7W	CRI>80	
<b>3H32M.12L.</b> □	dim. IGBT - Triac	€ 1.100,00	
Led color 2700K	Nominal lm 806	Beam spread 180°	

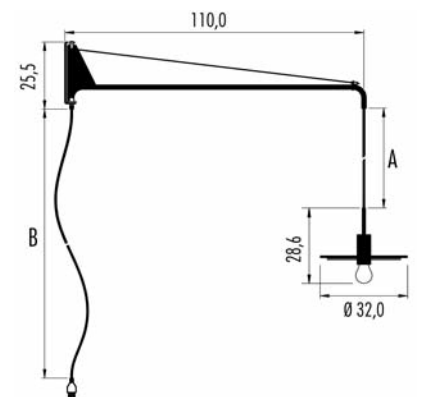

IP20	A+B=300cm	CE	∇
220-240V	e27 7W	CRI>80	
<b>3H32L.12L.</b> □	dim. IGBT - Triac	€ 1.100,00	
Led color 2700K	Nominal lm 806	Beam spread 180°	

Pop P40 A Chandelier

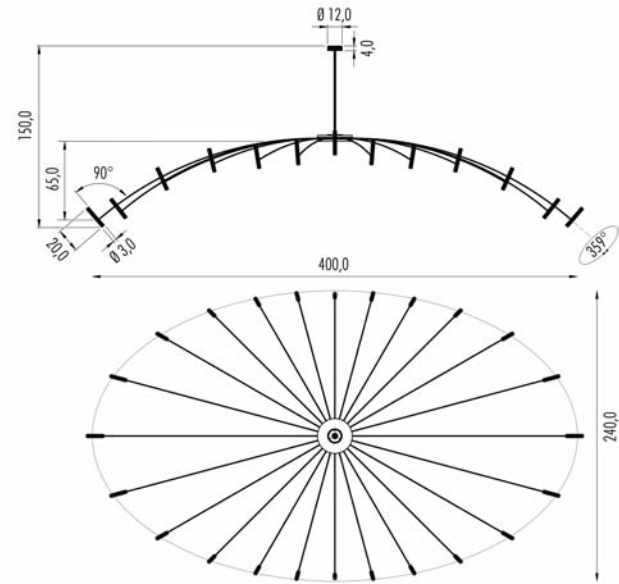

IP20	MC-E=3	CE
220-240V	24x6,0W	CRI>95
3P40A.2 M.02		€ 8.700,00
3P40A.2 M.06		€ 8.700,00
3P40A.2 M.B		€ 9.900,00
3P40A.2 M.C		€ 9.900,00
3P40A.2 M.G		€ 9.900,00
3P40A.2 M.P		€ 9.900,00
3P40A.2 M.R		€ 9.900,00
<b>Led color</b>	<b>Nominal lm</b>	<b>Beam spread</b>
2 = 2700K	24 x 664	35°
3 = 3000K	24 x 689	

**3DRV.024.DIM** DALI - Push - 1...10V € 110,00  
 remote installation: need 2 unit to order  
 installazione remota: necessario ordinare 2 unità

Pop P40 B Chandelier

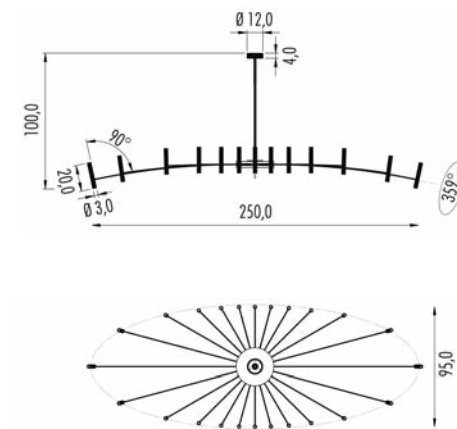

IP20	MC-E=3	CE
220-240V	24x6,0W	CRI>95
3P40B.2 M.02		€ 7.500,00
3P40B.2 M.06		€ 7.500,00
3P40B.2 M.B		€ 8.600,00
3P40B.2 M.C		€ 8.600,00
3P40B.2 M.G		€ 8.600,00
3P40B.2 M.P		€ 8.600,00
3P40B.2 M.R		€ 8.600,00
<b>Led color</b>	<b>Nominal lm</b>	<b>Beam spread</b>
2 = 2700K	24 x 664	35°
3 = 3000K	24 x 689	

**3DRV.024.DIM** DALI - Push - 1...10V € 110,00  
 remote installation: need 2 unit to order  
 installazione remota: necessario ordinare 2 unità

Frame - Struttura
02 ● Black - Nero
06 ○ White - Bianco
B ● Blue - Blu
C ● Copper - Rame
G ● Green - Verde
P ● Rose - Rosa
R ● Red - Rosso

Pop P40 R Chandelier

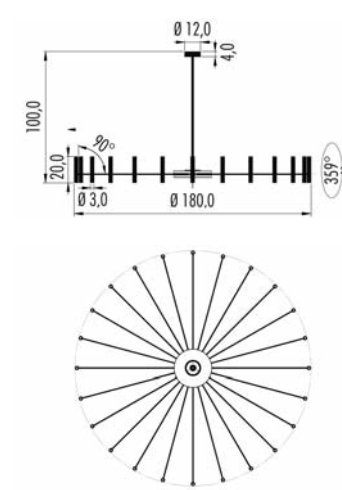

IP20	MC-E=3	CE
220-240V	24x6,0W	CRI>95
3P40R.2 M.02		€ 7.800,00
3P40R.2 M.06		€ 7.800,00
3P40R.2 M.B		€ 8.700,00
3P40R.2 M.C		€ 8.700,00
3P40R.2 M.G		€ 8.700,00
3P40R.2 M.P		€ 8.700,00
3P40R.2 M.R		€ 8.700,00
<b>Led color</b>	<b>Nominal lm</b>	<b>Beam spread</b>
2 = 2700K	24 x 664	35°
3 = 3000K	24 x 689	

**3DRV.024.DIM** DALI - Push - 1...10V € 110,00  
 remote installation: need 2 unit to order  
 installazione remota: necessario ordinare 2 pz.

Frame - Struttura
02 ● Black - Nero
06 ○ White - Bianco
B ● Blue - Blu
C ● Copper - Rame
G ● Green - Verde
P ● Rose - Rosa
R ● Red - Rosso

P50 Pinocchio

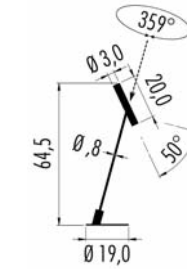

IP20	MC-E=3	CE
100-240V	6W CRI>95	dimmmable
4P50.2 M.02	With honeycomb	€ 520,00
4P50.2 M.06	With honeycomb	€ 520,00
4P50.2 M.B	With honeycomb	€ 599,00
4P50.2 M.C	With honeycomb	€ 599,00
4P50.2 M.G	With honeycomb	€ 599,00
4P50.2 M.P	With honeycomb	€ 599,00
4P50.2 M.R	With honeycomb	€ 599,00
<b>Led color</b>	<b>Nominal lm</b>	<b>Beam spread</b>
2 = 2700K	824	35°
3 = 3000K	861	
4 = 4000K	888	

P55 Pinocchio

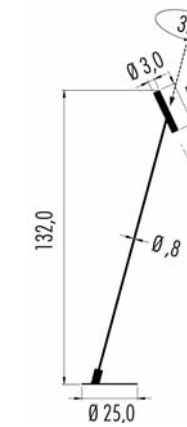

IP20	MC-E=3	CE
100-240V	6W CRI>95	dimmmable
4P55.2 M.02	With honeycomb	€ 650,00
4P55.2 M.06	With honeycomb	€ 650,00
4P55.2 M.B	With honeycomb	€ 750,00
4P55.2 M.C	With honeycomb	€ 750,00
4P55.2 M.G	With honeycomb	€ 750,00
4P55.2 M.P	With honeycomb	€ 750,00
4P55.2 M.R	With honeycomb	€ 750,00
<b>Led color</b>	<b>Nominal lm</b>	<b>Beam spread</b>
2 = 2700K	824	35°
3 = 3000K	861	
4 = 4000K	888	

with honeycomb = con frangiluce

Frame - Struttura
02 ● Black - Nero
06 ○ White - Bianco
B ● Blue - Blu
C ● Copper - Rame
G ● Green - Verde
P ● Rose - Rosa
R ● Red - Rosso

Ⓜ note for Pop Chandelier - note per Pop Chandelier:

Two given electronic gears (remote installation) for double switching on (alternating mode).  
 I due trasformatori forniti (da installare in remoto) comandano la doppia accensione - separata e alternata - dei 24 led (12+12).



### Pop P122 - P202 Brooklyn ARC trimless

For plasterboard. Per cartongesso

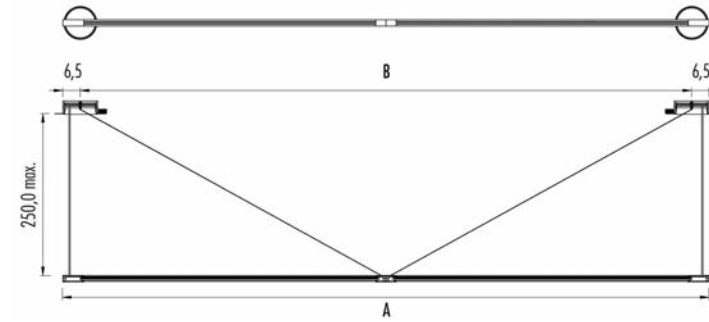

Housing for plasterboard - Cassaforma cartongesso  $\varnothing$  14,0cm

1Z00.120.01 x2 € 60,00 each

Housing for brickwork - Cassaforma laterizio

1M00.120.01 x2 € 140,00 each

### Pop P123 - P203 Brooklyn CUP

external canopy - rosone esterno

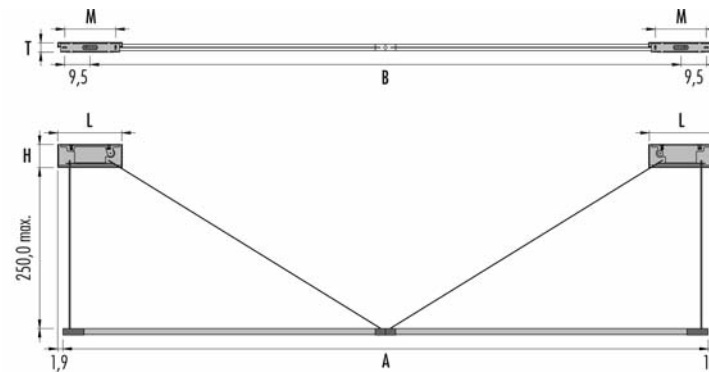

	Frame - Struttura	Canopy - Rosone	Wire - Cavo
02 ●	Black - Nero	Black - Nero	Black - Nero
06 ○	White - Bianco	White - Bianco	Black - Nero

Need two feeds for the installation - Sono necessarie due linee di alimentazione

#### Pop P122 ARC

IP20	220-240V	2x19W	CRI>95
3P122.4	L.□	on/off	€ 1.400,00
A = 240cm B = 227cm			

Led color	Nominal lm	Beam spread
2 = 2700K	2x2085	106°
3 = 3000K	2x2204	

#### Pop P202 ARC

IP20	220-240V	2x32W	CRI>95
3P202.4	L.□	on/off	€ 2.000,00
A = 384cm B = 371cm			

Led color	Nominal lm	Beam spread
2 = 2700K	2x3474	106°
3 = 3000K	2x3672	

Dimmable option:  
DALI - Push - 1...10V € 110,00  
Remote installation - need 2 units to order  
Installazione remota: ordinare 2 unità

#### Pop P123 CUP

IP20	220-240V	2x19W	CRI>95
3P123.4	L.□	on/off	€ 1.600,00
A = 240cm B = 219,8cm			
L = 24,0cm H = 8,6cm T = 4,1cm M = 19,0cm			

Led color	Nominal lm	Beam spread
2 = 2700K	2x2085	106°
3 = 3000K	2x2204	

#### Pop P203 CUP

IP20	220-240V	2x32W	CRI>95
3P203.4	L.□	on/off	€ 2.200,00
A = 384cm B = 363,8cm			
L = 28,0cm H = 13,6cm T = 4,7cm M = 23,5cm			

Led color	Nominal lm	Beam spread
2 = 2700K	2x3474	106°
3 = 3000K	2x3672	

### Pop P120 - P200 ARC with trim

For plasterboard. Per cartongesso

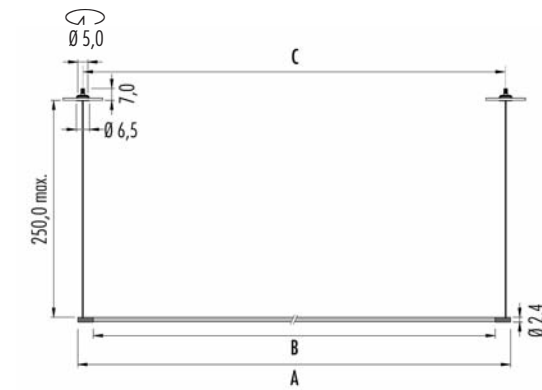

#### Pop P120 ARC

IP20	220-240V	19W	CRI>95
3PA1.4	L.□	on/off	€ 750,00
A = 124cm B = 108,4cm C = 119cm			

Led color	Nominal lm	Beam spread
2 = 2700K	2085	106°
3 = 3000K	2204	

#### Pop P200 ARC

IP20	220-240V	32W	CRI>95
3PA2.4	L.□	on/off	€ 1.050,00
A = 196cm B = 180,4cm C = 191cm			

Led color	Nominal lm	Beam spread
2 = 2700K	3474	106°
3 = 3000K	3672	

Dimmable option:  
DALI - Push - 1...10V € 110,00  
remote installation: need 1 unit to order  
Installazione remota: ordinare 1 unità

	Frame - Struttura	ARC canopy - Rosone	CUP canopy - Rosone	Wire - Cavo
02 ●	Black - Nero	Black - Nero	Black - Nero	Black - Nero
06 ○	White - Bianco	White - Bianco	White - Bianco	Black - Nero

ARC version only - solo versione ARC:

Electronic gear to be placed in remote position - Posizionare il trasformatore in remoto

### Pop P120 - P200 CUP

external canopy - rosone esterno

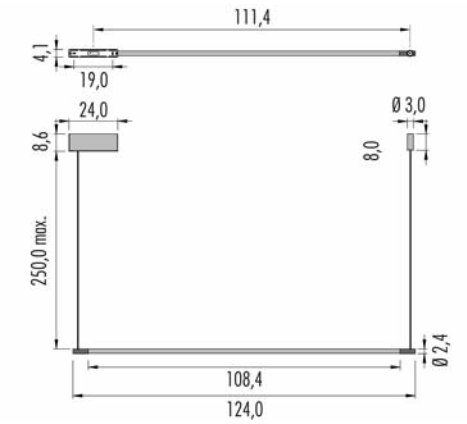

#### Pop P120 CUP

IP20	220-240V	19W	CRI>95
3PC1.4	L.□	on/off	€ 750,00
A = 124cm B = 108,4cm C = 119cm			

Led color	Nominal lm	Beam spread
2 = 2700K	2085	106°
3 = 3000K	2204	

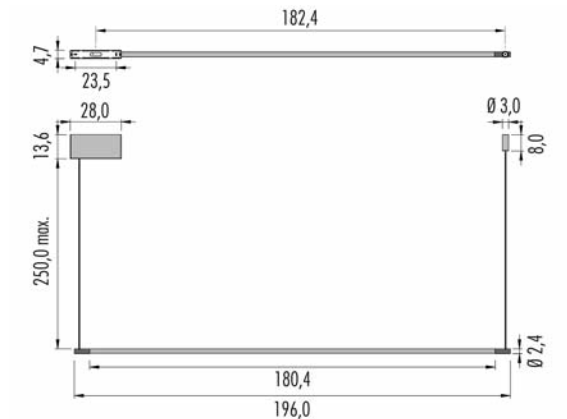

#### Pop P200 CUP

IP20	220-240V	32W	CRI>95
3PC2.4	L.□	on/off	€ 1.050,00
A = 196cm B = 180,4cm C = 191cm			

Led color	Nominal lm	Beam spread
2 = 2700K	3474	106°
3 = 3000K	3672	

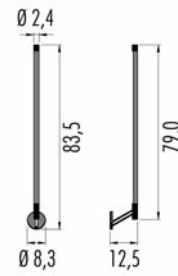
**Pop Up 1** wall - parete

IP20	220-240V	12W CRI>95	on/off
3PU1.4	L.02		€ 480,00
3PU1.4	L.06		€ 480,00
3PU1.4	L.CB		€ 530,00
3PU1.4	L.CR		€ 530,00

Electronic gear to be placed in remote position  
Posizionare il trasformatore in remoto

Led color	Nominal lm	Beam spread
2 = 2700K	1332	106°
3 = 3000K	1408	

Dimmable option:  
DALI - Push - 1...10V  
Remote installation  
Installazione remota

**3KIT.024.DIM** € 110,00

Frame - Struttura  Plate - Piastra

02	● Black - Nero	● Black - Nero
06	○ White - Bianco	○ White - Bianco
CB	● Copper - Rame	● Blue - Blu
CR	● Copper - Rame	● Red - Rosso

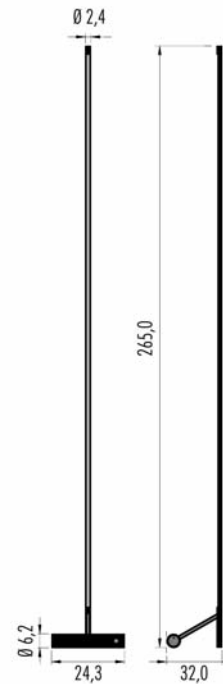
**Pop Up 207** floor - terra

IP20	220-240V	MC-E=3	26W	CRI>95
3P207.B	L.□	dimnable		€ 1.500,00
Led color	Nominal lm	Beam spread		
2 = 2700K	2928	106°		
3 = 3000K	3072			

Frame - Struttura

02	● Black - Nero
06	○ White - Bianco

**Tim T124 - T196 ARC** with trim

For plasterboard. Per cartongesso

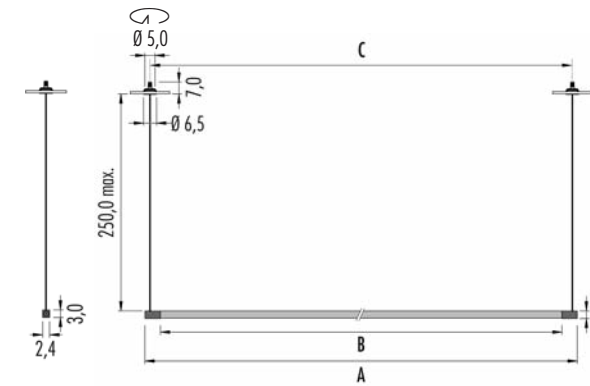
**Tim T124 ARC**

IP20	220-240V	2x19W	CRI>95
3TA1.4	L.□	on/off	€ 1.050,00
double switches up and down accensione separata per luce superiore ed inferiore			
A = 124cm B = 108,4cm C = 119cm			

Led color	Nominal lm	Beam spread
2 = 2700K	2x2085	106°
3 = 3000K	2x2204	

**Tim T196 ARC**

IP20	220-240V	2x32W	CRI>95
3TA2.4	L.□	on/off	€ 1.250,00
double switches up and down accensione separata per luce superiore ed inferiore			
A = 196cm B = 180,4cm C = 191cm			

Led color	Nominal lm	Beam spread
2 = 2700K	2x3474	106°
3 = 3000K	2x3672	

Dimmable option:  
DALI - Push - 1...10V  
Remote installation - need 2 unit to order  
Installazione remota - ordinare 2 unità

**3KIT.024.DIM** € 110,00

Frame - Struttura  Canopy - Rosone  Wire - Cavo

02	● Black - Nero	● Black - Nero	● Black - Nero
06	○ White - Bianco	○ White - Bianco	● Black - Nero

ARC version only - solo versione ARC:

Electronic gear to be placed in remote position - Posizionare il trasformatore in remoto.

**Tim T124 - T196 CUP**

external canopy - rosone esterno

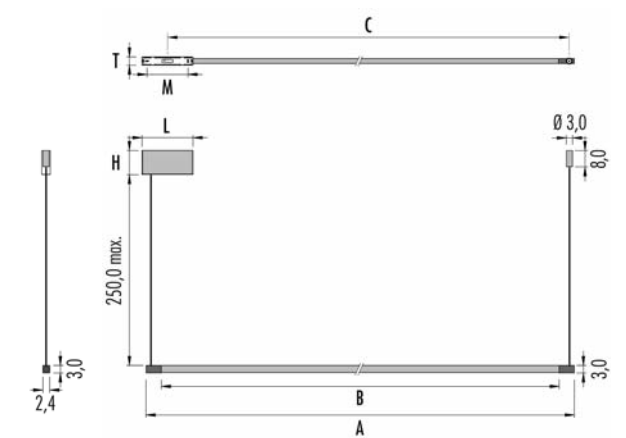
**Tim T124 CUP**

IP20	220-240V	2x19W	CRI>95
3TC1.4	L.□	on/off	€ 1.050,00
singular switch up and down - dimmable on request Unica accensione per luce superiore ed inferiore. A richiesta dimmerabilità DALI - PUSH - 1...10V			
A = 124cm B = 108,4cm C = 110,4cm L = 24,0cm H = 8,6cm T = 4,1cm M = 19,0cm			

Led color	Nominal lm	Beam spread
2 = 2700K	2x2085	106°
3 = 3000K	2x2204	

**Tim T196 CUP**

IP20	220-240V	2x32W	CRI>95
3TC2.4	L.□	on/off	€ 1.250,00
singular switch up and down Unica accensione per luce superiore ed inferiore.			
A = 196cm B = 180,4cm C = 182,4cm L = 28,0cm H = 13,6cm T = 4,7cm M = 23,5cm			

Led color	Nominal lm	Beam spread
2 = 2700K	2x3474	106°
3 = 3000K	2x3672	

**X1A** Ø 7,0 trimless

For plasterboard. Per cartongesso

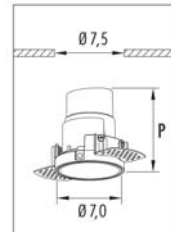

UGR&lt;19

IP40		CE	∇	⊞
220V ÷ 240V				
<b>3X1A.210.</b> □	<b>GU10 led</b>	€	<b>42,00</b>	
IP40	Flicker < 20%	CE	∇	⊞
220V ÷ 240V	<b>LED 9,5W</b>	CRI>90		
<b>3X1A.K</b> ■▲□	dimmi IGBT - TRIAC	€	<b>66,00</b>	
■ <i>Led color</i>	<i>Nominal lm</i>	▲ <i>Beam spread</i>		
2 = 2700K	834	M = 36°		
3 = 3000K	877	S = 24°		

IP40	⊙	MC-E=3	CE	∇	⊞
200m/A	<b>LED 8W</b>	CRI>95	<i>Driver included</i>		
<b>3X1A.02</b> ■▲□	ON/OFF	€	<b>76,00</b>		
<b>3X1A.E2</b> ■▲□	DALI - Push	€	<b>133,00</b>		
<b>3X1A.G2</b> ■▲□	0...10V	€	<b>90,00</b>		
<b>3X1A.D2</b> ■▲□	dimmi IGBT - TRIAC	€	<b>86,00</b>		
■ <i>Led color</i>	<i>Nominal lm</i>	▲ <i>Beam spread</i>			
2 = 2700K	829	L = 60°			
3 = 3000K	872	M = 32°			
		S = 24°			

IP40	⊙	MC-E=3	CE	∇	⊞
350m/A	<b>LED 12,2W</b>	CRI>90	<i>Driver included</i>		
<b>3X1A.03</b> ■▲□	ON/OFF	€	<b>76,00</b>		
<b>3X1A.E3</b> ■▲□	DALI	€	<b>133,00</b>		
<b>3X1A.G3</b> ■▲□	Push - 1...10V	€	<b>115,00</b>		
<b>3X1A.D3</b> ■▲□	dimmi IGBT - TRIAC	€	<b>88,00</b>		
■ <i>Led color</i>	<i>Nominal lm</i>	▲ <i>Beam spread</i>			
2 = 2700K	1140	M = 36°			
3 = 3000K	1170	S = 24°			

IP40	⊙	DimToWarm	CE	∇	⊞
220V ÷ 240V	LED 6W	CRI 95	<i>Driver included</i>		
<b>3X1A.E2W</b> ■▲□	DALI	€	<b>142,00</b>		
<b>3X1A.D2W</b> ■▲□	dimmi IGBT - TRIAC	€	<b>111,00</b>		
■ <i>Led color</i>	<i>Nominal lm</i>	▲ <i>Beam spread</i>			
W= max 3000K	max 445 lm	M = 30°			
min. 1800K	min. 10 lm	S = 18°			

Emergency unit: (inverter + battery. Driver not included)

<b>3KIT.900.01</b> (1-1)	1:00 hour	€	<b>110,00</b>
<b>3KIT.900.03</b> (1-1)	3:00 hours	€	<b>145,00</b>

Housing - Cassafornia ↻ Ø 7,5 cm

<b>1X00.0XA.01</b>	€	<b>19,00</b>
--------------------	---	--------------

Honeycomb - Frangiluce

<b>1X00.H50.02</b>	for IP40	€	<b>4,00</b>
<b>1X00.H50.54</b>	for IP54	€	<b>5,00</b>

X1A	P
3X1A.210.□	GU10 led —
3X1A.K■▲□	led 9,5W 13,0
3X1A.x2■▲□	led 8W 9,2
3X1A.x2■▲9□	led 8W 9,2
3X1A.x3■▲□	led 12,2W 11,7
3X1A.D2W■▲□	led 8W 9,2

□ Reflector - Parabola

<b>02</b> ●	Black - Nero
<b>06</b> ●	White - Bianco
<b>CH</b> ●	Chrome - Cromo
<b>CB</b> ●	Black Chrome - Cromo scuro
<b>GD</b> ●	Gold - Oro

**X1B** Ø 8,5 with trim

For plasterboard. Per cartongesso

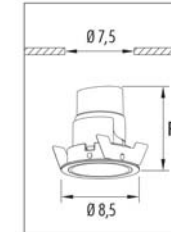

UGR&lt;19

IP40		CE	∇	⊞
220V ÷ 240V				
<b>3X1B.210.</b> □	<b>GU10 led</b>	€	<b>51,00</b>	
IP40	Flicker < 20%	CE	∇	⊞
220V ÷ 240V	<b>LED 9,5W</b>	CRI>90		
<b>3X1B.K</b> ■▲□	dimmi IGBT - TRIAC	€	<b>75,00</b>	
■ <i>Led color</i>	<i>Nominal lm</i>	▲ <i>Beam spread</i>		
2 = 2700K	834	M = 36°		
3 = 3000K	877	S = 24°		

IP40	⊙	MC-E=3	CE	∇	⊞
200m/A	<b>LED 8W</b>	CRI>95	<i>Driver included</i>		
<b>3X1B.02</b> ■▲□	ON/OFF	€	<b>84,00</b>		
<b>3X1B.E2</b> ■▲□	DALI - Push	€	<b>143,00</b>		
<b>3X1B.G2</b> ■▲□	0...10V	€	<b>98,00</b>		
<b>3X1B.D2</b> ■▲□	dimmi IGBT - TRIAC	€	<b>94,00</b>		
■ <i>Led color</i>	<i>Nominal lm</i>	▲ <i>Beam spread</i>			
2 = 2700K	829	L = 60°			
3 = 3000K	872	M = 32°			
		S = 24°			

IP40	⊙	MC-E=3	CE	∇	⊞
350m/A	<b>LED 12,2W</b>	CRI>90	<i>Driver included</i>		
<b>3X1B.03</b> ■▲□	ON/OFF	€	<b>84,00</b>		
<b>3X1B.E3</b> ■▲□	DALI	€	<b>143,00</b>		
<b>3X1B.G3</b> ■▲□	Push - 1...10V	€	<b>123,00</b>		
<b>3X1B.D3</b> ■▲□	dimmi IGBT - TRIAC	€	<b>96,00</b>		
■ <i>Led color</i>	<i>Nominal lm</i>	▲ <i>Beam spread</i>			
2 = 2700K	1140	M = 36°			
3 = 3000K	1170	S = 24°			

X1B	P
3X1B.210.□	GU10 led —
3X1B.K■▲□	led 9,5W 13,0
3X1B.x2■▲□	led 8W 9,2
3X1B.x2■▲9□	led 8W 9,2
3X1B.x3■▲□	led 12,2W 11,7
3X1B.D2W■▲□	led 8W 9,2

□ Reflector with BLACK ring  
Parabola con anello NERO

<b>22</b> ●	Black - Nero
<b>26</b> ●	White - Bianco
<b>2H</b> ●	Chrome - Cromo
<b>2B</b> ●	Black Chrome - Cromo scuro
<b>2G</b> ●	Gold - Oro

□ Reflector with WHITE ring  
Parabola con anello BIANCO

<b>62</b> ●	Black - Nero
<b>66</b> ●	White - Bianco
<b>6H</b> ●	Chrome - Cromo
<b>6B</b> ●	Black Chrome - Cromo scuro
<b>6G</b> ●	Gold - Oro

IP54	⊙	MC-E=3	CE	∇	⊞
200m/A	<b>LED 8W</b>	CRI>95	<i>Driver included</i>		
<b>3X1B.02</b> ■▲9□	ON/OFF	€	<b>130,00</b>		
<b>3X1B.E2</b> ■▲9□	DALI - Push	€	<b>189,00</b>		
<b>3X1B.G2</b> ■▲9□	0...10V	€	<b>144,00</b>		
<b>3X1B.D2</b> ■▲9□	dimmi IGBT - TRIAC	€	<b>140,00</b>		
■ <i>Led color</i>	<i>Nominal lm</i>	▲ <i>Beam spread</i>			
2 = 2700K	829	L = 60°			
3 = 3000K	872	M = 32°			
		S = 24°			

IP40	⊙	DimToWarm	CE	∇	⊞
220V ÷ 240V	LED 6W	CRI 95	<i>Driver included</i>		
<b>3X1B.E2W</b> ■▲□	DALI	€	<b>149,00</b>		
<b>3X1B.D2W</b> ■▲□	dimmi IGBT - TRIAC	€	<b>118,00</b>		
■ <i>Led color</i>	<i>Nominal lm</i>	▲ <i>Beam spread</i>			
W= max 3000K	max 445 lm	M = 30°			
min. 1800K	min. 10 lm	S = 18°			

Emergency unit: (inverter + battery. Driver not included)

<b>3KIT.900.01</b> (1-1)	1:00 hour	€	<b>110,00</b>
<b>3KIT.900.03</b> (1-1)	3:00 hours	€	<b>145,00</b>

Honeycomb - Frangiluce

<b>1X00.H50.02</b>	for IP40	€	<b>4,00</b>
<b>1X00.H50.54</b>	for IP54	€	<b>5,00</b>

**X2A** Ø 7,0 trimless

For plasterboard. Per cartongesso

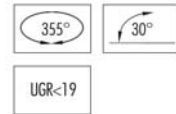
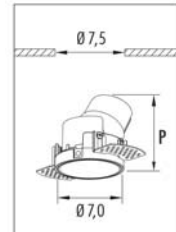

UGR&lt;19

IP40	CE	CE	▽	□
220V ÷ 240V				
<b>3X2A.210.</b> □	<b>GU10</b> led	€	<b>42,00</b>	
<hr/>				
IP40	Flicker < 20%	CE	▽	□
220V ÷ 240V	<b>LED 9,5W</b>	CRI>90		
<b>3X2A.K</b> ■■▲.□	dimmi IGBT - TRIAC	€	<b>66,00</b>	
■ <i>Led color</i>	<i>Nominal lm</i>	▲ <i>Beam spread</i>		
2 = 2700K	834	M = 36°		
3 = 3000K	877	S = 24°		

IP40	MC-E=3	CE	▽	⊕
200m/A	<b>LED 8W</b>	CRI>95	<i>Driver included</i>	
<b>3X2A.02</b> ■■▲.□	ON/OFF	€	<b>76,00</b>	
<b>3X2A.E2</b> ■■▲.□	DALI - Push	€	<b>133,00</b>	
<b>3X2A.G2</b> ■■▲.□	0...10V	€	<b>90,00</b>	
<b>3X2A.D2</b> ■■▲.□	dimmi IGBT - TRIAC	€	<b>86,00</b>	
■ <i>Led color</i>	<i>Nominal lm</i>	▲ <i>Beam spread</i>		
2 = 2700K	829	L = 60°		
3 = 3000K	872	M = 32°		
		S = 24°		

<b>IP54</b>	MC-E=3	CE	▽	⊕
200m/A	<b>LED 8W</b>	CRI>95	<i>Driver included</i>	
<b>3X2A.02</b> ■■▲9 □	ON/OFF	€	<b>120,00</b>	
<b>3X2A.E2</b> ■■▲9 □	DALI - Push	€	<b>182,00</b>	
<b>3X2A.G2</b> ■■▲9 □	0...10V	€	<b>137,00</b>	
<b>3X2A.D2</b> ■■▲9 □	dimmi IGBT - TRIAC	€	<b>133,00</b>	
■ <i>Led color</i>	<i>Nominal lm</i>	▲ <i>Beam spread</i>		
2 = 2700K	829	L = 60°		
3 = 3000K	872	M = 32°		
		S = 24°		

Housing - Cassafornia ↻ Ø 7,5 cm

**1X00.0XA.01** € **19,00**

IP40	MC-E=3	CE	▽	⊕
350m/A	<b>LED 12,2W</b>	CRI>90	<i>Driver included</i>	
<b>3X2A.03</b> ■■▲.□	ON/OFF	€	<b>76,00</b>	
<b>3X2A.E3</b> ■■▲.□	DALI	€	<b>133,00</b>	
<b>3X2A.G3</b> ■■▲.□	Push - 1...10V	€	<b>115,00</b>	
<b>3X2A.D3</b> ■■▲.□	dimmi IGBT - TRIAC	€	<b>88,00</b>	
■ <i>Led color</i>	<i>Nominal lm</i>	▲ <i>Beam spread</i>		
2 = 2700K	1140	M = 36°		
3 = 3000K	1170	S = 24°		

IP40	DimToWarm	CE	▽	⊕
220V ÷ 240V	LED 6W	CRI 95	<i>Driver included</i>	
<b>3X2A.E2W</b> ▲.□	DALI	€	<b>142,00</b>	
<b>3X2A.D2W</b> ▲.□	dimmi IGBT - TRIAC	€	<b>111,00</b>	
■ <i>Led color</i>	<i>Nominal lm</i>	▲ <i>Beam spread</i>		
W= max 3000K	max 445 lm	M = 30°		
min. 1800K	min. 10 lm	S = 18°		

Emergency unit: (inverter + battery. Driver not included)

<b>3KIT.900.01</b> (1-1)	1:00 hour	€	<b>110,00</b>
<b>3KIT.900.03</b> (1-1)	3:00 hours	€	<b>145,00</b>

Honeycomb - Frangiluce

<b>1X00.H50.02</b>	for IP40	€	<b>4,00</b>
<b>1X00.H50.54</b>	for IP54	€	<b>5,00</b>

**X2B** Ø 8,5 with trim

For plasterboard. Per cartongesso

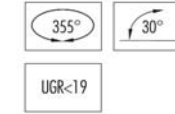
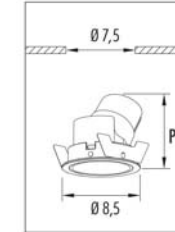

UGR&lt;19

IP40	CE	CE	▽	□
220V ÷ 240V				
<b>3X2B.210.</b> □	<b>GU10</b> led	€	<b>51,00</b>	
<hr/>				
IP40	Flicker < 20%	CE	▽	□
220V ÷ 240V	<b>LED 9,5W</b>	CRI>90		
<b>3X2B.K</b> ■■▲.□	dimmi IGBT - TRIAC	€	<b>75,00</b>	
■ <i>Led color</i>	<i>Nominal lm</i>	▲ <i>Beam spread</i>		
2 = 2700K	834	M = 36°		
3 = 3000K	877	S = 24°		

IP40	MC-E=3	CE	▽	⊕
200m/A	<b>LED 8W</b>	CRI>95	<i>Driver included</i>	
<b>3X2B.02</b> ■■▲.□	ON/OFF	€	<b>84,00</b>	
<b>3X2B.E2</b> ■■▲.□	DALI - Push	€	<b>143,00</b>	
<b>3X2B.G2</b> ■■▲.□	0...10V	€	<b>98,00</b>	
<b>3X2B.D2</b> ■■▲.□	dimmi IGBT - TRIAC	€	<b>94,00</b>	
■ <i>Led color</i>	<i>Nominal lm</i>	▲ <i>Beam spread</i>		
2 = 2700K	829	L = 60°		
3 = 3000K	872	M = 32°		
		S = 24°		

<b>IP54</b>	MC-E=3	CE	▽	⊕
200m/A	<b>LED 8W</b>	CRI>95	<i>Driver included</i>	
<b>3X2B.02</b> ■■▲9 □	ON/OFF	€	<b>130,00</b>	
<b>3X2B.E2</b> ■■▲9 □	DALI - Push	€	<b>189,00</b>	
<b>3X2B.G2</b> ■■▲9 □	0...10V	€	<b>144,00</b>	
<b>3X2B.D2</b> ■■▲9 □	dimmi IGBT - TRIAC	€	<b>140,00</b>	
■ <i>Led color</i>	<i>Nominal lm</i>	▲ <i>Beam spread</i>		
2 = 2700K	829	L = 60°		
3 = 3000K	872	M = 32°		
		S = 24°		

IP40	MC-E=3	CE	▽	⊕
350m/A	<b>LED 12,2W</b>	CRI>90	<i>Driver included</i>	
<b>3X2B.03</b> ■■▲.□	ON/OFF	€	<b>84,00</b>	
<b>3X2B.E3</b> ■■▲.□	DALI	€	<b>143,00</b>	
<b>3X2B.G3</b> ■■▲.□	Push - 1...10V	€	<b>123,00</b>	
<b>3X2B.D3</b> ■■▲.□	dimmi IGBT - TRIAC	€	<b>96,00</b>	
■ <i>Led color</i>	<i>Nominal lm</i>	▲ <i>Beam spread</i>		
2 = 2700K	1140	M = 36°		
3 = 3000K	1170	S = 24°		

IP40	DimToWarm	CE	▽	⊕
220V ÷ 240V	LED 6W	CRI 95	<i>Driver included</i>	
<b>3X2B.E2W</b> ▲.□	DALI	€	<b>149,00</b>	
<b>3XBA.D2W</b> ▲.□	dimmi IGBT - TRIAC	€	<b>118,00</b>	
■ <i>Led color</i>	<i>Nominal lm</i>	▲ <i>Beam spread</i>		
W= max 3000K	max 445 lm	M = 30°		
min. 1800K	min. 10 lm	S = 18°		

Emergency unit: (inverter + battery. Driver not included)

<b>3KIT.900.01</b> (1-1)	1:00 hour	€	<b>110,00</b>
<b>3KIT.900.03</b> (1-1)	3:00 hours	€	<b>145,00</b>

Honeycomb - Frangiluce

<b>1X00.H50.02</b>	for IP40	€	<b>4,00</b>
<b>1X00.H50.54</b>	for IP54	€	<b>5,00</b>

□	<i>Reflector - Parabola</i>
<b>02</b> ●	Black - Nero
<b>06</b> ●	White - Bianco
<b>CH</b> ●	Chrome - Cromo
<b>CB</b> ●	Black Chrome - Cromo scuro
<b>GD</b> ●	Gold - Oro

**X3A** Ø 7,0 trimless

For plasterboard. Per cartongesso

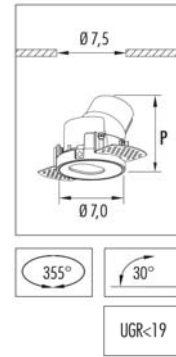

IP40		CE	∇	⊞
220V ÷ 240V				
<b>3X3A.210.06</b>	GU10 led	€	42,00	
IP40	Flicker < 20%	CE	∇	⊞
220V ÷ 240V	LED 9,5W	CRI>90		
<b>3X3A.K</b>	dimmi IGBT - TRIAC	€	66,00	
■ Led color	Nominal lm	▲ Beam spread		
2 = 2700K	834	M = 36°		
3 = 3000K	877	S = 24°		

X3A	P
3X3A.210.□	GU10 led —
3X3A.K	led 9,5W 13,0
3X3A.x2	led 8W 9,2
3X3A.x2	led 8W 9,2
3X3A.x3	led 12,2W 11,7
3X3A.D2 W	led 8W 9,2

## Reflector - Parabola

06	White - Bianco
----	----------------

IP40	MC-E=3	CE	∇	⊞
200m/A	LED 8W CRI>95	Driver included		
<b>3X3A.02</b>	ON/OFF	€	76,00	
<b>3X3A.E2</b>	DALI - Push	€	133,00	
<b>3X3A.G2</b>	0...10V	€	90,00	
<b>3X3A.D2</b>	dimmi IGBT - TRIAC	€	86,00	
■ Led color	Nominal lm	▲ Beam spread		
2 = 2700K	829	L = 60°		
3 = 3000K	872	M = 32°		
		S = 24°		

IP54	MC-E=3	CE	∇	⊞
200m/A	LED 8W CRI>95	Driver included		
<b>3X3A.02</b>	ON/OFF	€	120,00	
<b>3X3A.E2</b>	DALI - Push	€	182,00	
<b>3X3A.G2</b>	0...10V	€	137,00	
<b>3X3A.D2</b>	dimmi IGBT - TRIAC	€	133,00	
■ Led color	Nominal lm	▲ Beam spread		
2 = 2700K	829	L = 60°		
3 = 3000K	872	M = 32°		
		S = 24°		

IP40	MC-E=3	CE	∇	⊞
350m/A	LED 12,2W CRI>90	Driver included		
<b>3X3A.03</b>	ON/OFF	€	76,00	
<b>3X3A.E3</b>	DALI	€	133,00	
<b>3X3A.G3</b>	Push - 1...10V	€	115,00	
<b>3X3A.D3</b>	dimmi IGBT - TRIAC	€	88,00	
■ Led color	Nominal lm	▲ Beam spread		
2 = 2700K	1140	M = 36°		
3 = 3000K	1170	S = 24°		

IP40	DimToWarm	CE	∇	⊞
220V ÷ 240V	LED 6W CRI 95	Driver included		
<b>3X3A.E2W</b>	DALI	€	142,00	
<b>3X3A.D2W</b>	dimmi IGBT - TRIAC	€	111,00	
■ Led color	Nominal lm	▲ Beam spread		
W= max 3000K	max 445 lm	M = 30°		
min. 1800K	min. 10 lm	S = 18°		

Emergency unit: (inverter + battery. Driver not included)

<b>3KIT.900.01</b> (1-1)	1:00 hour	€	110,00
<b>3KIT.900.03</b> (1-1)	3:00 hours	€	145,00

Housing - Cassafornia Ø 7,5 cm

<b>1X00.0XA.01</b>	€	19,00
--------------------	---	-------

Honeycomb - Frangiluce

<b>1X00.H50.02</b>	for IP40	€	4,00
<b>1X00.H50.54</b>	for IP54	€	5,00

**X3B** Ø 8,5 with trim

For plasterboard. Per cartongesso

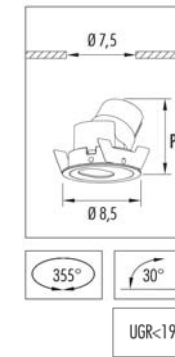

IP40		CE	∇	⊞
220V ÷ 240V				
<b>3X3B.210.06</b>	GU10 led	€	51,00	
IP40	Flicker < 20%	CE	∇	⊞
220V ÷ 240V	LED 9,5W	CRI>90		
<b>3X3B.K</b>	dimmi IGBT - TRIAC	€	75,00	
■ Led color	Nominal lm	▲ Beam spread		
2 = 2700K	834	M = 36°		
3 = 3000K	877	S = 24°		

X3B	P
3X3B.210.□	GU10 led —
3X3B.K	led 9,5W 13,0
3X3B.x2	led 8W 9,2
3X3B.x2	led 8W 9,2
3X3B.x3	led 12,2W 11,7
3X3B.D2 W	led 8W 9,2

Reflector with WHITE ring  
Parabola con anello BIANCO

06	White - Bianco
----	----------------

IP40	MC-E=3	CE	∇	⊞
200m/A	LED 8W CRI>95	Driver included		
<b>3X3B.02</b>	ON/OFF	€	84,00	
<b>3X3B.E2</b>	DALI - Push	€	143,00	
<b>3X3B.G2</b>	0...10V	€	98,00	
<b>3X3B.D2</b>	dimmi IGBT - TRIAC	€	94,00	
■ Led color	Nominal lm	▲ Beam spread		
2 = 2700K	829	L = 60°		
3 = 3000K	872	M = 32°		
		S = 24°		

IP54	MC-E=3	CE	∇	⊞
200m/A	LED 8W CRI>95	Driver included		
<b>3X3B.02</b>	ON/OFF	€	130,00	
<b>3X3B.E2</b>	DALI - Push	€	189,00	
<b>3X3B.G2</b>	0...10V	€	144,00	
<b>3X3B.D2</b>	dimmi IGBT - TRIAC	€	140,00	
■ Led color	Nominal lm	▲ Beam spread		
2 = 2700K	829	L = 60°		
3 = 3000K	872	M = 32°		
		S = 24°		

IP40	MC-E=3	CE	∇	⊞
350m/A	LED 12,2W CRI>90	Driver included		
<b>3X3B.03</b>	ON/OFF	€	84,00	
<b>3X3B.E3</b>	DALI	€	143,00	
<b>3X3B.G3</b>	Push - 1...10V	€	123,00	
<b>3X3B.D3</b>	dimmi IGBT - TRIAC	€	96,00	
■ Led color	Nominal lm	▲ Beam spread		
2 = 2700K	1140	M = 36°		
3 = 3000K	1170	S = 24°		

IP40	DimToWarm	CE	∇	⊞
220V ÷ 240V	LED 6W CRI 95	Driver included		
<b>3X3B.E2W</b>	DALI	€	149,00	
<b>3X3B.D2W</b>	dimmi IGBT - TRIAC	€	118,00	
■ Led color	Nominal lm	▲ Beam spread		
W= max 3000K	max 445 lm	M = 30°		
min. 1800K	min. 10 lm	S = 18°		

Emergency unit: (inverter + battery. Driver not included)

<b>3KIT.900.01</b> (1-1)	1:00 hour	€	110,00
<b>3KIT.900.03</b> (1-1)	3:00 hours	€	145,00

Honeycomb - Frangiluce

<b>1X00.H50.02</b>	for IP40	€	4,00
<b>1X00.H50.54</b>	for IP54	€	5,00

**X4A** Ø 7,0 trimless

For plasterboard. Per cartongesso

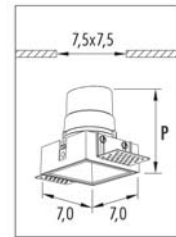

UGR&lt;19

IP40		CE	∇	□
220V ÷ 240V				
<b>3X4A.210.</b> □	GU10 led	€	<b>42,00</b>	
IP40	Flicker < 20%	CE	∇	□
220V ÷ 240V	<b>LED 9,5W</b>	CRI>90		
<b>3X4A.K</b> ■■▲▲.□	dimmi IGBT - TRIAC	€	<b>66,00</b>	
■ Led color	Nominal lm	▲ Beam spread		
2 = 2700K	834	M = 36°		
3 = 3000K	877	S = 24°		

IP40	©	MC-E=3	CE	∇	⚡
200m/A	<b>LED 8W</b>	CRI>95	Driver included		
<b>3X4A.02</b> ■■▲▲.□	ON/OFF	€	<b>76,00</b>		
<b>3X4A.E2</b> ■■▲▲.□	DALI - Push	€	<b>133,00</b>		
<b>3X4A.G2</b> ■■▲▲.□	0...10V	€	<b>90,00</b>		
<b>3X4A.D2</b> ■■▲▲.□	dimmi IGBT - TRIAC	€	<b>86,00</b>		
■ Led color	Nominal lm	▲ Beam spread			
2 = 2700K	829	L = 60°			
3 = 3000K	872	M = 32°			
		S = 24°			

IP40	©	MC-E=3	CE	∇	⚡
350m/A	<b>LED 12,2W</b>	CRI>90	Driver included		
<b>3X4A.03</b> ■■▲▲.□	ON/OFF	€	<b>76,00</b>		
<b>3X4A.E3</b> ■■▲▲.□	DALI	€	<b>133,00</b>		
<b>3X4A.G3</b> ■■▲▲.□	Push - 1...10V	€	<b>115,00</b>		
<b>3X4A.D3</b> ■■▲▲.□	dimmi IGBT - TRIAC	€	<b>88,00</b>		
■ Led color	Nominal lm	▲ Beam spread			
2 = 2700K	1140	M = 36°			
3 = 3000K	1170	S = 24°			

IP40	©	DimToWarm	CE	∇	⚡
220V ÷ 240V	LED 6W	CRI 95	Driver included		
<b>3X4A.E2W</b> ■■▲▲.□	DALI	€	<b>142,00</b>		
<b>3X4A.D2W</b> ■■▲▲.□	dimmi IGBT - TRIAC	€	<b>111,00</b>		
■ Led color	Nominal lm	▲ Beam spread			
W= max 3000K	max 445 lm	M = 30°			
min. 1800K	min. 10 lm	S = 18°			

Emergency unit: (inverter + battery. Driver not included)

<b>3KIT.900.01</b> (1-1)	1:00 hour	€	<b>110,00</b>
<b>3KIT.900.03</b> (1-1)	3:00 hours	€	<b>145,00</b>

Housing for plasterboard - Cassaforma cartongesso 7,4x7,4 cm

<b>1X00.04A.01</b>	€	<b>19,00</b>
--------------------	---	--------------

Honeycomb - Frangiluce

<b>1X00.H50.02</b>	for IP40	€	<b>4,00</b>
<b>1X00.H50.54</b>	for IP54	€	<b>5,00</b>

	X4A	P
3X4A.210.□	GU10 led	—
3X4A.K ■■▲▲.□	led 9,5W	13,0
3X4A.x2 ■■▲▲.□	led 8W	9,2
3X4A.x2 ■■▲▲9 □	led 8W	9,2
3X4A.x3 ■■▲▲.□	led 12,2W	11,7
3X4A.D2 W ■■▲▲.□	led 8W	9,2

□ Reflector - Parabola

02	■	Black - Nero
06	□	White - Bianco
CH	■	Chrome - Cromo
CB	■	Black Chrome - Cromo scuro
GD	■	Gold - Oro

**X4B** Ø 8,5 with trim

For plasterboard. Per cartongesso

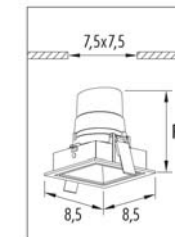

UGR&lt;19

IP40		CE	∇	□
220V ÷ 240V				
<b>3X4B.210.</b> □	GU10 led	€	<b>51,00</b>	
IP40	Flicker < 20%	CE	∇	□
220V ÷ 240V	<b>LED 9,5W</b>	CRI>90		
<b>3X4B.K</b> ■■▲▲.□	dimmi IGBT - TRIAC	€	<b>75,00</b>	
■ Led color	Nominal lm	▲ Beam spread		
2 = 2700K	834	M = 36°		
3 = 3000K	877	S = 24°		

IP40	©	MC-E=3	CE	∇	⚡
200m/A	<b>LED 8W</b>	CRI>95	Driver included		
<b>3X4B.02</b> ■■▲▲.□	ON/OFF	€	<b>84,00</b>		
<b>3X4B.E2</b> ■■▲▲.□	DALI - Push	€	<b>143,00</b>		
<b>3X4B.G2</b> ■■▲▲.□	0...10V	€	<b>98,00</b>		
<b>3X4B.D2</b> ■■▲▲.□	dimmi IGBT - TRIAC	€	<b>94,00</b>		
■ Led color	Nominal lm	▲ Beam spread			
2 = 2700K	829	L = 60°			
3 = 3000K	872	M = 32°			
		S = 24°			

IP40	©	MC-E=3	CE	∇	⚡
350m/A	<b>LED 12,2W</b>	CRI>90	Driver included		
<b>3X4B.03</b> ■■▲▲.□	ON/OFF	€	<b>84,00</b>		
<b>3X4B.E3</b> ■■▲▲.□	DALI	€	<b>143,00</b>		
<b>3X4B.G3</b> ■■▲▲.□	Push - 1...10V	€	<b>123,00</b>		
<b>3X4B.D3</b> ■■▲▲.□	dimmi IGBT - TRIAC	€	<b>96,00</b>		
■ Led color	Nominal lm	▲ Beam spread			
2 = 2700K	1140	M = 36°			
3 = 3000K	1170	S = 24°			

IP54	©	MC-E=3	CE	∇	⚡
200m/A	<b>LED 8W</b>	CRI>95	Driver included		
Available ONLY with black or white reflector					
Disponibile SOLO con parabola nera o bianca					
<b>3X4B.02</b> ■■▲▲9 □	ON/OFF	€	<b>130,00</b>		
<b>3X4B.E2</b> ■■▲▲9 □	DALI - Push	€	<b>189,00</b>		
<b>3X4B.G2</b> ■■▲▲9 □	0...10V	€	<b>144,00</b>		
<b>3X4B.D2</b> ■■▲▲9 □	dimmi IGBT - TRIAC	€	<b>140,00</b>		
■ Led color	Nominal lm	▲ Beam spread			
2 = 2700K	829	L = 60°			
3 = 3000K	872	M = 32°			
		S = 24°			

IP40	©	DimToWarm	CE	∇	⚡
220V ÷ 240V	LED 6W	CRI 95	Driver included		
<b>3X4B.E2W</b> ■■▲▲.□	DALI	€	<b>149,00</b>		
<b>3X4B.D2W</b> ■■▲▲.□	dimmi IGBT - TRIAC	€	<b>118,00</b>		
■ Led color	Nominal lm	▲ Beam spread			
W= max 3000K	max 445 lm	M = 30°			
min. 1800K	min. 10 lm	S = 18°			

Emergency unit: (inverter + battery. Driver not included)

<b>3KIT.900.01</b> (1-1)	1:00 hour	€	<b>110,00</b>
<b>3KIT.900.03</b> (1-1)	3:00 hours	€	<b>145,00</b>

Honeycomb - Frangiluce

<b>1X00.H50.02</b>	for IP40	€	<b>4,00</b>
<b>1X00.H50.54</b>	for IP54	€	<b>5,00</b>

**GUN 2A**  $\varnothing 4,3$  trimless  
For plasterboard. Per cartongesso

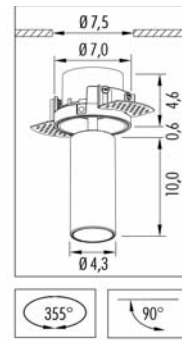

IP40	MC-E=3	CE	LED	CRI>95	Driver included
200m/A	LED 8W				
<b>3G2A.02</b>	M. □ ON/OFF	€	<b>116,00</b>		
<b>3G2A.E2</b>	M. □ DALI - Push	€	<b>176,00</b>		
<b>3G2A.G2</b>	M. □ 0...10V	€	<b>130,00</b>		
<b>3G2A.D2</b>	M. □ dimm IGBT - TRIAC	€	<b>127,00</b>		
■ Led color	Nominal lm	▲ Beam spread			
2 = 2700K	829	36°			
3 = 3000K	872				

Housing - Cassafurma  $\varnothing 7,5$  cm

**1X00.0XA.01** € **19,00**



Option: Cross Anti-glare Ring - Anello anti abbagliamento a croce  
**1XG2.C43.02** € **6,00**

□ Frame - Struttura  
02 ● Black - Nero  
06 ○ White - Bianco

**GUN 2B**  $\varnothing 4,3$  with trim  
For plasterboard. Per cartongesso

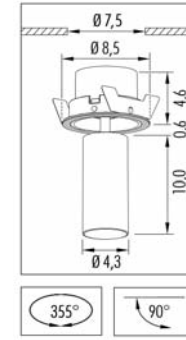

IP40	MC-E=3	CE	LED	CRI>95	Driver included
200m/A	LED 8W				
<b>3G2B.02</b>	M. □ ON/OFF	€	<b>123,00</b>		
<b>3G2B.E2</b>	M. □ DALI - Push	€	<b>183,00</b>		
<b>3G2B.G2</b>	M. □ 0...10V	€	<b>138,00</b>		
<b>3G2B.D2</b>	M. □ dimm IGBT - TRIAC	€	<b>134,00</b>		
■ Led color	Nominal lm	▲ Beam spread			
2 = 2700K	829	36°			
3 = 3000K	872				



Option: Cross Anti-glare Ring - Anello anti abbagliamento a croce  
**1XG2.C43.02** € **6,00**

□ Frame - Struttura  
02 ● Black - Nero  
06 ○ White - Bianco

**GUN 2C**  $\varnothing 4,3$   
wall/ceiling - parete/plafone

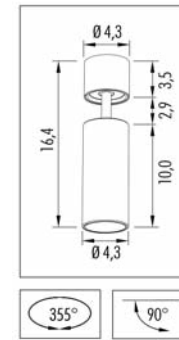

IP40	MC-E=3	CE	LED	CRI>95	Driver included
200m/A	LED 8W				
<b>3G2C.02</b>	M. □ ON/OFF	€	<b>135,00</b>		
<b>3G2C.E2</b>	M. □ DALI - Push	€	<b>183,00</b>		
<b>3G2C.G2</b>	M. □ 0...10V	€	<b>138,00</b>		
<b>3G2C.D2</b>	M. □ dimm IGBT - TRIAC	€	<b>134,00</b>		
■ Led color	Nominal lm	▲ Beam spread			
2 = 2700K	829	36°			
3 = 3000K	872				



Option: Cross Anti-glare Ring - Anello anti abbagliamento a croce  
**1XG2.C43.02** € **6,00**

□ Frame - Struttura  
02 ● Black - Nero  
06 ○ White - Bianco

**GUN 2W**  $\varnothing 4,3$   
wall - parete

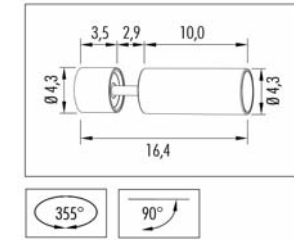

IP40	MC-E=3	CE	LED	CRI>95	Driver included
120m/A	LED 4W				
<b>3G2W.02</b>	M. □ ON/OFF	€	<b>135,00</b>		
<b>3G2W.G2</b>	M. □ 0...10V	€	<b>138,00</b>		
<b>3G2W.D2</b>	M. □ dimm IGBT - TRIAC	€	<b>134,00</b>		
■ Led color	Nominal lm	▲ Beam spread			
2 = 2700K	496	36°			
3 = 3000K	532				



Option: Cross Anti-glare Ring - Anello anti abbagliamento a croce  
**1XG2.C43.02** € **6,00**

□ Frame - Struttura  
02 ● Black - Nero  
06 ○ White - Bianco

**X5B 4,5x4,5 with trim**

For plasterboard. Per cartongesso

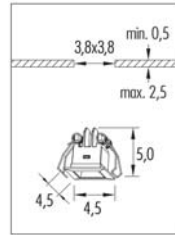

UGR&lt;19

IP20	MC-E=3	CE	LED 3W	CRI>95	Driver included
700m/A			<b>3X5B.01</b>	<b>S.02</b>	ON/OFF € <b>50,00</b>
			<b>3X5B.F1</b>	<b>S.02</b>	DALI Push 0/1...10V <i>On request</i>
<b>Led color</b>	<b>Nominal lm</b>	<b>Beam spread</b>			
2 = 2700K	180	S = 22°			
3 = 3000K	193				

 Frame - Struttura *Optical lens - Ottica*
**02**  Black - Nero *PMMA material - Lente in PMMA*
**X5B 16,5x4,5 with trim**

For plasterboard. Per cartongesso

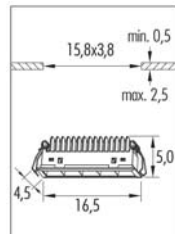

UGR&lt;19

IP20	MC-E=3	CE	LED 5x2W	CRI>95	Driver included
700m/A			<b>3X5B.02</b>	<b>02</b>	ON/OFF € <b>150,00</b>
			<b>3X5B.E2</b>	<b>02</b>	DALI - Push € <b>220,00</b>
			<b>3X5B.G2</b>	<b>02</b>	0/1...10V € <b>220,00</b>
<b>Led color</b>	<b>Nominal lm</b>	<b>Beam spread</b>			
2 = 2700K	900	M = 50°			
3 = 3000K	965	S = 22°			

 Frame - Struttura *Optical lens - Ottica*
**02**  Black - Nero *PMMA material - Lente in PMMA*
**X5B 31,5x4,5 with trim**

For plasterboard. Per cartongesso

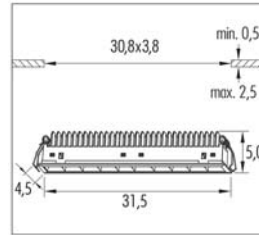

UGR&lt;19

IP20	MC-E=3	CE	LED 10x2W	CRI>95	Driver included
700m/A			<b>3X5B.03</b>	<b>02</b>	ON/OFF € <b>240,00</b>
			<b>3X5B.E3</b>	<b>02</b>	DALI - Push € <b>310,00</b>
			<b>3X5B.G3</b>	<b>02</b>	0/1...10V € <b>310,00</b>
<b>Led color</b>	<b>Nominal lm</b>	<b>Beam spread</b>			
2 = 2700K	1800	M = 50°			
3 = 3000K	1930	S = 22°			

 Frame - Struttura *Optical lens - Ottica*
**02**  Black - Nero *PMMA material - Lente in PMMA*
**X5B 46,4x4,5 with trim**

For plasterboard. Per cartongesso

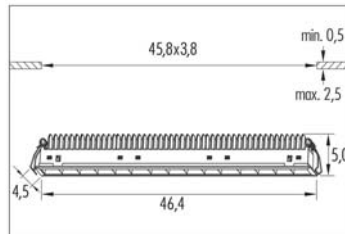

UGR&lt;19

IP20	MC-E=3	CE	LED 15x2W	CRI>95	Driver included
700m/A			<b>3X5B.04</b>	<b>02</b>	ON/OFF € <b>350,00</b>
			<b>3X5B.E4</b>	<b>02</b>	DALI - Push € <b>420,00</b>
			<b>3X5B.G4</b>	<b>02</b>	0/1...10V € <b>420,00</b>
<b>Led color</b>	<b>Nominal lm</b>	<b>Beam spread</b>			
2 = 2700K	2700	M = 50°			
3 = 3000K	2895	S = 22°			

 Frame - Struttura *Optical lens - Ottica*
**02**  Black - Nero *PMMA material - Lente in PMMA*
**X7R Ø 8,5**

Ceiling - Plafone

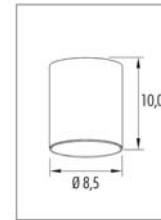

UGR&lt;19

IP20	MC-E=3	CE	LED 10W	CRI>95	Driver included
220V ÷ 240V			<b>3X7R.H2</b>	<b>02</b>	dimm IGBT - TRIAC € <b>169,00</b>
<b>Led color</b>	<b>Nominal lm</b>	<b>Beam spread</b>			
2 = 2700K	1042	L = 50°			
3 = 3000K	1096	S = 24°			

 Reflector with **BLACK** cylinder  
*Parabola con cilindro NERO*

- 22**  Black - Nero  
**26**  White - Bianco  
**2H**  Chrome - Cromo  
**2B**  Black Chrome - Cromo scuro  
**2G**  Gold - Oro

 Reflector with **WHITE** cylinder  
*Parabola con cilindro BIANCO*

- 62**  Black - Nero  
**66**  White - Bianco  
**6H**  Chrome - Cromo  
**6B**  Black Chrome - Cromo scuro  
**6G**  Gold - Oro

Honeycomb - Frangiluce

**1X07.H50.02** € **5,00**
**X7C 8,5 x 8,5**

Ceiling - Plafone

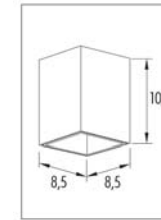

UGR&lt;19

IP20	MC-E=3	CE	LED 10W	CRI>95	Driver included
220V ÷ 240V			<b>3X7C.H2</b>	<b>02</b>	dimm IGBT - TRIAC € <b>169,00</b>
<b>Led color</b>	<b>Nominal lm</b>	<b>Beam spread</b>			
2 = 2700K	1042	L = 50°			
3 = 3000K	1096	S = 24°			

 Reflector with square **BLACK** frame  
*Parabola con struttura NERA*

- 22**  Black - Nero  
**26**  White - Bianco  
**2H**  Chrome - Cromo  
**2B**  Black Chrome - Cromo scuro  
**2G**  Gold - Oro

 Reflector with **WHITE** frame  
*Parabola con struttura BIANCA*

- 62**  Black - Nero  
**66**  White - Bianco  
**6H**  Chrome - Cromo  
**6B**  Black Chrome - Cromo scuro  
**6G**  Gold - Oro

Honeycomb - Frangiluce

**1X07.H50.02** € **5,00**



**X-Rail 48V** magnet track system  
sistema a binario magnetico

X-Rail is a magnet track system with low voltage of 48V, available in the following versions: recessed trimless (only for plasterboard), surface or pendant. The 4 track conductors can be used for an on/off power supply circuit, or for a dimmable "Noise Free" circuit, as described in the wiring schemes.

X-Gun, X-Dark, X-Line and X-Pendant products are suitable for different needs of lighting. They are fixed into the X-Rail profile by the magnet and the click safety lock.

*X-Rail è un sistema a binario magnetico a 48V, disponibile nella versione ad incasso senza bordo (solo per cartongesso), a plafone ed a sospensione. I 4 conduttori del binario possono essere utilizzati per l'accensione on/off, oppure per una dimmerazione "Noise Free", come da schemi di cablaggio. I prodotti X-Gun, X-Dark, X-Line ed X-Sospensioni soddisfano diverse tipologie di illuminazione, e si installano al binario X-Rail attraverso il magnete ed un ulteriore dispositivo meccanico di sicurezza.*

Magnet system  
Sistema magnetico

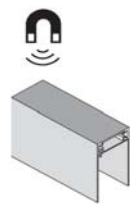

Bidirectional installation  
Installazione bidirezionale

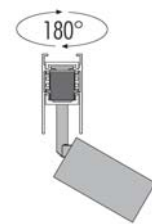

Click&Safety Lock  
Fissaggio meccanico di sicurezza

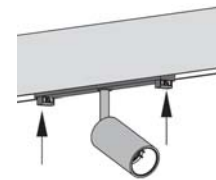

Adjustable  
Orientabile

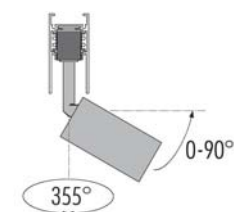

WiFi Technology by App  
Tecnologia WiFi tramite App

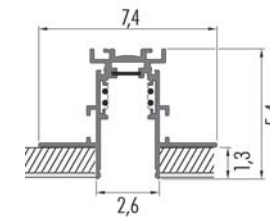

Recessed trimless only for plasterboard - *Incasso senza bordo solo per cartongesso*

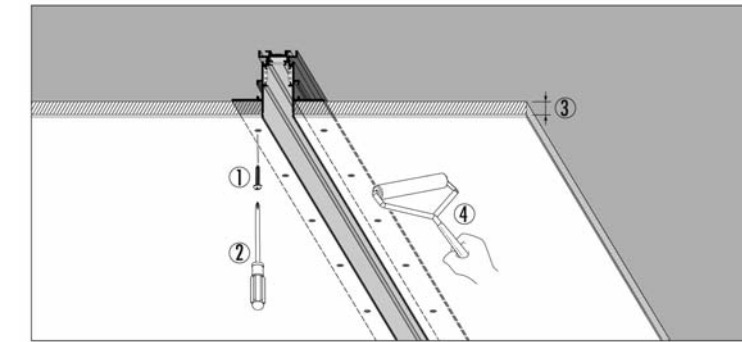

- 1 Screw
- 2 Screw Driver
- 3 Gypsum Board 13,3mm
- 4 Plastering

- 1 Viti
- 2 Cacciavite
- 3 Spessore cartongesso 13,3mm
- 4 Stuccare e rasare

Surface - *Plafone*

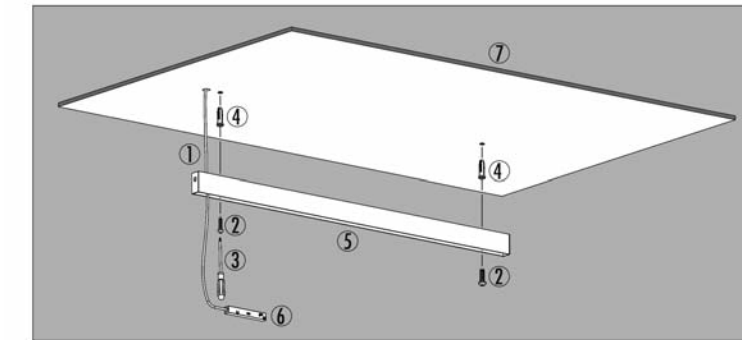

- 1 DC 48V Input
- 2 Screw
- 3 Screw Driver
- 4 Expansion Screw
- 5 Track
- 6 DC Connecting Box
- 7 Ceiling

- 1 DC48V in entrata
- 2 Vite
- 3 Cacciavite
- 4 Tassello
- 5 Binario
- 6 Connettore Feed DC
- 7 Soffitto

Pendant - *Sospensione*

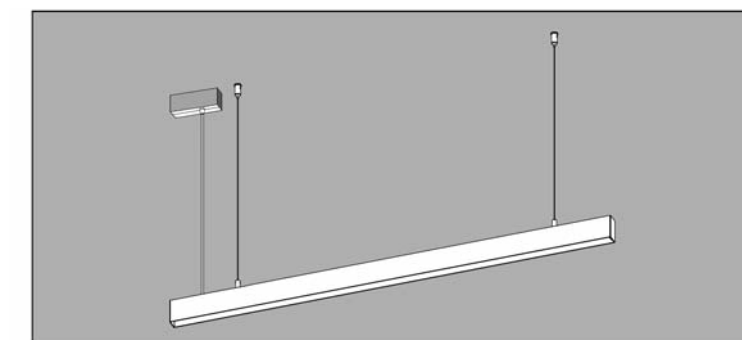

- 1 Steel cable
- 2 Mounting Plate
- 3 End cup for track
- 4 Track
- 5 Screw
- 6 Screw
- 7 DC Connecting Box

- 1 Cavi in acciaio
- 2 Staffa per sospensione
- 3 Tappo di chiusura binario
- 4 Binario
- 5 Vite
- 6 Vite
- 7 Connettore Feed DC

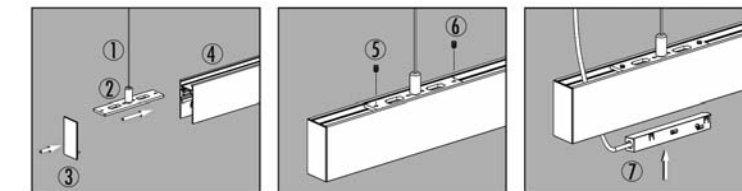

Devices Installation Scheme - Schemi di cablaggio

**Option 1:**  
on/off solution  
soluzione on/off

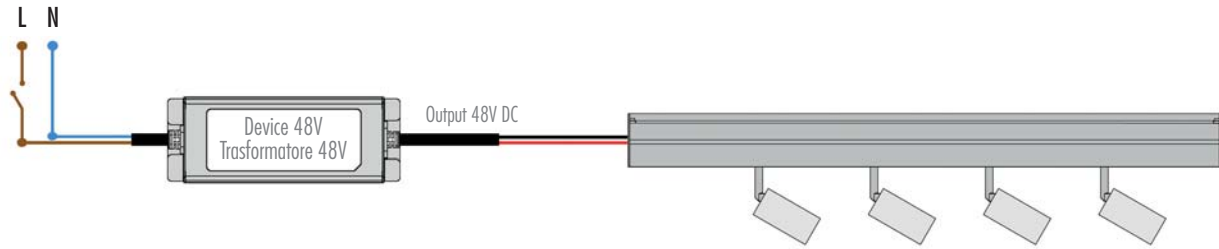

**Option 2:**  
dimmable "Noise Free" DALI: standard addressable solution  
soluzione dimmerabile "Noise Free" tramite riconoscimento standard

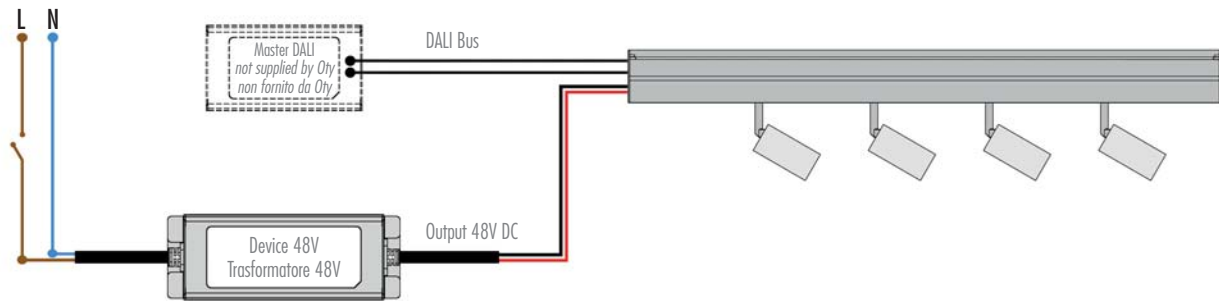

**Option 3:**  
dimmable "Noise Free" WiFi: auto addressable solution  
soluzione dimmerabile WiFi "Noise Free" tramite riconoscimento auto indirizzante

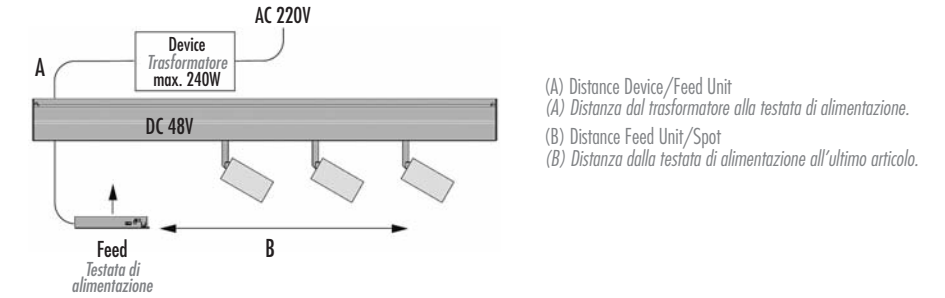
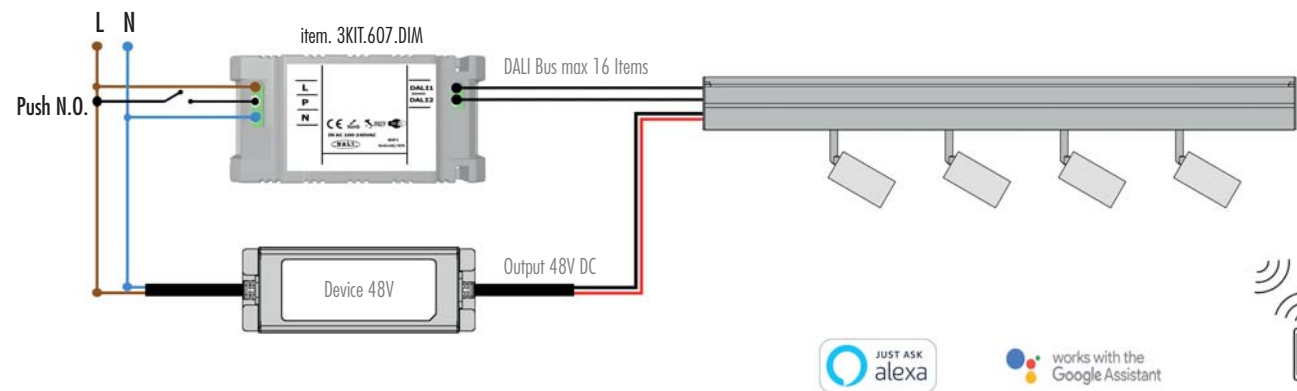

Drop voltage table - Tabella caduta di tensione

Device	(A)	5 mt.	10 mt.	20 mt.	30 mt.
100W	(B)	50 mt.	50 mt.	30 mt.	10 mt.
150W	(B)	20 mt.	15 mt.	5 mt.	—
240W	(B)	15 mt.	10 mt.	—	—

Technical characteristics of the devices for 48V Track - Caratteristiche tecniche dei dispositivi per binario 48V

Code	W	Size (mm)	CV	Connectable fixtures	Max distance	Cable section	Tech. Info
3KIT.048.100	100	199x63x36	48V	Max: 70W	See chart here above	2.5mm <sup>2</sup>	100-305V 47-63Hz € 95,00
3KIT.048.150	150	219x63x36	48V	Max: 105W	See chart here above	2.5mm <sup>2</sup>	100-305V 47-63Hz € 120,00
3KIT.048.245	240	244x71x38	48V	Max: 150W	See chart here above	2.5mm <sup>2</sup>	100-305V 47-63Hz € 140,00

Led warranty ONLY when used together with devices bought from Oty srl  
I Led sono coperti da garanzia solo se utilizzati in abbinamento con i dispositivi acquistabili dalla Oty srl.

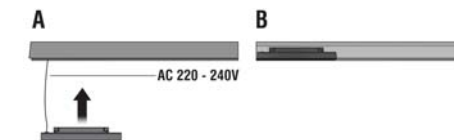

Technical characteristics of the devices for 48V Track  
Caratteristiche tecniche dei dispositivi per binario 48V

Code	W	Size	CV	Connectable fixtures
3KIT.048.060	60	242mm	48V	Max: 48W € 260,00
Tech. Info	120-277V		47-63Hz	

WiFi device "Noise Free" to dim the light -  
Dispositivo dimmerabile WiFi "Noise Free"

Code	Size (mm)	Price
3KIT.607.DIM	80x40x25mm	€ 150,00

It works by WiFi with smart phone, Google Assistant or Amazon Alexa. App on request.  
Il dispositivo lavora in WiFi tramite smartphone, con Assistente Google o Alexa Amazon. App su richiesta.

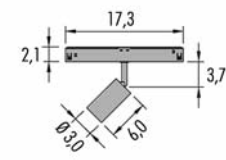

**X - Gun 1**  $\varnothing 3,0$ 

IP20 MC-E=3

48V **LED 3W** CRI>95

3XG1.02 on/off € 140,00

3XG1.G2 dimmable € 175,00

Led color	Nominal lm	Beam spread
2 = 2700K	427	S = 24°
3 = 3000K	430	T = 10°

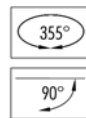

Option: Cross Anti-glare Ring - Anello anti abbagliamento a croce

1XG1.C30.02 € 6,00

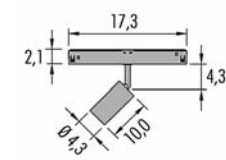
**X - Gun 2**  $\varnothing 4,3$ 

IP20 MC-E=3

48V **LED 8W** CRI>95

3XG2.03 on/off € 170,00

3XG2.G3 dimmable € 195,00

Led color	Nominal lm	Beam spread
2 = 2700K	829	S = 24°
3 = 3000K	872	T = 8°

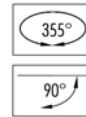

Option: Cross Anti-glare Ring - Anello anti abbagliamento a croce

1XG2.C43.02 € 6,00

 Frame - Struttura

02 Black - Nero

06 White - Bianco

CH Chrome - Cromo

GD Gold - Oro

Attention, before ordering the item:

- 1- Choose the appropriate 48V devices (100-150-240W), paying attention to the drop voltage table;
- 2- If you need to dim the light, choose the two options:
  - a. by a Master DALI (item not supplied by Oty);
  - b. by our dimming device 3KIT.607.DIM.
- 3- All our items are "Noise Free" dimming if installed as explained on the "devices installation scheme".

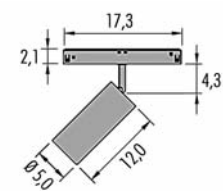
**X - Gun 3**  $\varnothing 5,0$ 

IP20 MC-E=3

48V **LED 13W** CRI>95

3XG3.03 on/off € 190,00

3XG3.G3 dimmable € 206,00

Led color	Nominal lm	Beam spread
2 = 2700K	1300	M = 36°
3 = 3000K	1425	S = 24°

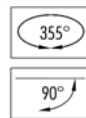
Option: Honeycomb - Frangiluce  $\varnothing 3,8$  cm

1X07.H50.02 € 5,00

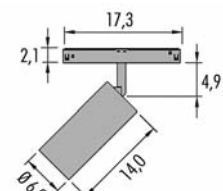
**X - Gun 4**  $\varnothing 6,0$ 

IP20 MC-E=3

48V **LED 23W** CRI>95

3XG4.05 on/off € 200,00

3XG4.G5 dimmable € 240,00

Led color	Nominal lm	Beam spread
2 = 2700K	2131	S = 24°
3 = 3000K	2241	T = 15°

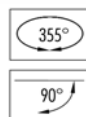
Option: Honeycomb - Frangiluce  $\varnothing 5,2$  cm

1XG4.H60.02 € 6,00

Option: Barn Door  $\varnothing 6,0$  cm

1XG4.D60.02 € 10,00

 Frame - Struttura

02 Black - Nero

06 White - Bianco

Attenzione, prima di ordinare l'articolo:

- 1- scegliere il trasformatore 48V adeguato (100-150-240W) prestando attenzione alla tabella di caduta tensione;
- 2- per dimmerare la luce, scegliere una delle due opzioni:
  - a. tramite Master Dali (articolo non fornito da Oty srl);
  - b. tramite il nostro dispositivo 3KIT.607.DIM
- 3- Tutti i ns. articoli sono dimmerabili "Noise Free" se installati come da schema di cablaggio.

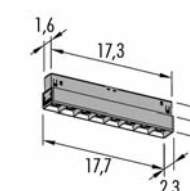
**X - Dark 1**

IP20 MC-E=3

48V **LED 8W** CRI>95

3XD1.02 on/off € 220,00

3XD1.G2 dimmable € 245,00

Led color	Nominal lm	Beam spread
2 = 2700K	720	M = 50°
3 = 3000K	772	T = 15°



X-Dark can be used as a single element, or for unlimited length compositions. Material: PMMA optical lens. Light distribution: symmetric.

X-Dark può essere usato come elemento singolo, oppure per composizioni di varie lunghezze. L'ottica delle lenti è in PMMA (Polimetilmetacrilato).

Distribuzione simmetrica della luce.

Frame - Struttura

02 Black - Nero

Attention, before ordering the item:

- 1- Choose the appropriate 48V devices (100-150-240W), paying attention to the drop voltage table;
- 2- If you need to dim the light, choose the two options:
  - a. by a Master DALI (item not supplied by Oty);
  - b. by our dimming device 3KIT.607.DIM.
- 3- All our items are "Noise Free" dimming if installed as explained on the "devices installation scheme".

Attenzione, prima di ordinare l'articolo:

- 1- scegliere il trasformatore 48V adeguato (100-150-240W) prestando attenzione alla tabella di caduta tensione;
- 2- per dimmerare la luce, scegliere una delle due opzioni:
  - a. tramite Master Dali (articolo non fornito da Oty srl);
  - b. tramite il nostro dispositivo 3KIT.607.DIM
- 3- Tutti i ns. articoli sono dimmerabili "Noise Free" se installati come da schema di cablaggio.

## X-Line 30 | 60 | 90 | 120

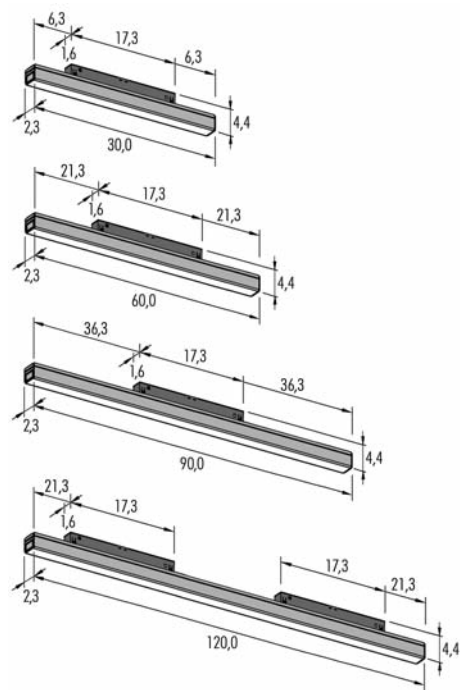

## X-Line 30cm

IP20	MC-E=3	CE	▽	⊕
48V	LED 5W	CRI>90		
3XL1.04 L.D1	on/off	€ 75,00		
3XL1.G4 L.D1	dimmmable	€ 160,00		

Led color	Nominal lm	Beam spread
2 = 2700K	460	120°
3 = 3000K	500	

## X-Line 60cm

IP20	MC-E=3	CE	▽	⊕
48V	LED 10W	CRI>90		
3XL2.04 L.D1	on/off	€ 100,00		
3XL2.G4 L.D1	dimmmable	€ 185,00		

Led color	Nominal lm	Beam spread
2 = 2700K	920	120°
3 = 3000K	1000	

## X-Line 90cm

IP20	MC-E=3	CE	▽	⊕
48V	LED 15W	CRI>90		
3XL3.04 L.D1	on/off	€ 135,00		
3XL3.G4 L.D1	dimmmable	€ 220,00		

Led color	Nominal lm	Beam spread
2 = 2700K	1380	120°
3 = 3000K	1500	

## X-Line 120cm

IP20	MC-E=3	CE	▽	⊕
48V	LED 20W	CRI>90		
3XL4.04 L.D1	on/off	€ 160,00		
3XL4.G4 L.D1	dimmmable	€ 245,00		

Led color	Nominal lm	Beam spread
2 = 2700K	1840	120°
3 = 3000K	2000	

X-Line can be used as a single element, or for unlimited length compositions without any dark zone. Material: PC optical cover. Light distribution: symmetric.

X-Line può essere usato come elemento singolo, o come modulo per composizioni di varie lunghezze senza alcuna zona d'ombra. Diffusore luce in PC (Policarbonato). Distribuzione simmetrica della luce.

X-Line 60,90 and 120 cm, are the only measures that can be used to correctly illuminate the corners.

X-Line 60,90 e 120 cm, sono le misure che devono essere usate per illuminare correttamente gli angoli.

Attention, before ordering the item:

- 1- Choose the appropriate 48V devices (100-150-240W), paying attention to the drop voltage table;
- 2- If you need to dim the light, choose the two options:
  - a. by a Master DALI (item not supplied by Oty);
  - b. by our dimming device 3KIT.607.DIM.
- 3- All our items are "Noise Free" dimming if installed as explained on the "devices installation scheme".

Attenzione, prima di ordinare l'articolo:

- 1- scegliere il trasformatore 48V adeguato (100-150-240W) prestando attenzione alla tabella di caduta tensione;
- 2- per dimmerare la luce, scegliere una delle due opzioni:
  - a. tramite Master Dali (articolo non fornito da Oty srl);
  - b. tramite il nostro dispositivo 3KIT.607.DIM
- 3- Tutti i ns. articoli sono dimmerabili "Noise Free" se installati come da schema di cablaggio.

## X-Pendant

Black power supply cable. Cavo di alimentazione, nero.

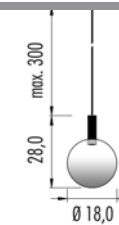

IP40	Bijou	CE	▽	⊕
48V	6W	CRI>90		
3BUX.02 S.□	on/off	€ 350,00		
3BUX.G2 S.□	dimmmable	€ 370,00		

Led color	Nominal lm	Beam spread
2 = 2700K	528	25°
3 = 3000K	552	

□ Cylinder - Cilindro

- 02 ● Black - Nero  
06 ○ White - Bianco  
C1 ● Copper Anodized - Rame anodizzato  
S1 ● Brass Anodized - Ottone anodizzato

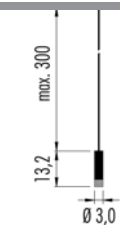

IP20	C'est Toi	CE	▽	⊕
48V	6W	CRI>90		
3CTX.02 S.□	on/off	€ 235,00		
3CTX.G2 S.□	dimmmable	€ 255,00		

Led color	Nominal lm	Beam spread
2 = 2700K	528	20°
3 = 3000K	552	

□ Diffuser color - Diffusore

- 02 ● Black - Nero  
06 ○ White - Bianco  
C1 ● Copper Anodized - Rame anodizzato  
S1 ● Brass Anodized - Ottone anodizzato

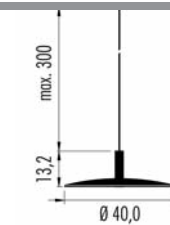

IP20	Chapeau	CE	▽	⊕
48V	6W	CRI>90		
3CHX.02 S.□	on/off	€ 325,00		
3CHX.G2 S.□	dimmmable	€ 345,00		

Led color	Nominal lm	Beam spread
2 = 2700K	528	20°
3 = 3000K	552	

□ Up Down

- 02 ●● Black/Black - Nero/Nero  
06 ○○ White/White - Bianco/Bianco  
CK ●● Copper Anodized/Black - Rame anodiz./Nero  
CW ●○ Copper Anodized/White - Rame anodiz./Bianco  
SK ●● Brass Anodized/Black - Ottone anodiz./Nero  
SW ●○ Brass Anodized/White - Ottone anodiz./Bianco

Black power supply cable. Cavo di alimentazione, nero.

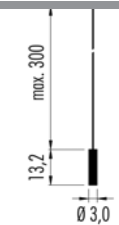

IP20	C'est Moi	CE	▽	⊕
48V	6W	CRI>90		
3CMX.02 S.□	on/off	€ 270,00		
3CMX.G2 S.□	dimmmable	€ 290,00		

Led color	Nominal lm	Beam spread
2 = 2700K	528	20°
3 = 3000K	552	

□ Diffuser color - Diffusore

- 02 ● Black - Nero 06 ○ White - Bianco

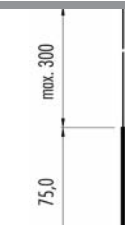

IP20	Petit	CE	▽	⊕
48V	2,3W	CRI>90		
3PTX.02 L.□	on/off	€ 295,00		
3PTX.G2 L.□	dimmmable	€ 315,00		

Led color	Nominal lm	Beam spread
2 = 2700K	237	60°
3 = 3000K	256	

□ Diffuser color - Diffusore

- 02 ● Black - Nero 06 ○ White - Bianco

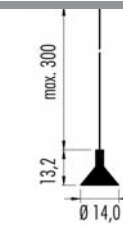

IP20	Chérie	CE	▽	⊕
48V	6W	CRI>90		
3CEX.02 S.□	on/off	€ 340,00		
3CEX.G2 S.□	dimmmable	€ 360,00		

Led color	Nominal lm	Beam spread
2 = 2700K	528	20°
3 = 3000K	552	

□ Diffuser color - Diffusore

- 02 ● Black - Nero 06 ○ White - Bianco

Recessed trimless - *Incasso senza bordo*

<b>1XR5.100.02</b>	100cm	Black - Nero	€ 105,00
<b>1XR5.100.06</b>	100cm	White - Bianco	€ 105,00
<b>1XR5.200.02</b>	200cm	Black - Nero	€ 220,00
<b>1XR5.200.06</b>	200cm	White - Bianco	€ 220,00
<b>1XR5.300.02</b>	300cm	Black - Nero	€ 335,00
<b>1XR5.300.06</b>	300cm	White - Bianco	€ 335,00



<b>1XR5.GAI.02</b>	Black - Nero	€ 85,00
--------------------	--------------	---------

Non electrified vertical internal corner - *Angolare interno verticale non elettrificato*

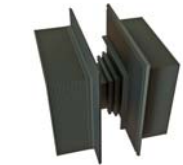

<b>1XR5.GAE.02</b>	Black - Nero	€ 85,00
--------------------	--------------	---------

Non electrified vertical external corner - *Angolare esterno verticale non elettrificato*



<b>1XR5.GAH.02</b>	Black - Nero	€ 85,00
<b>1XR5.GAH.06</b>	White - Bianco	€ 85,00

Non electrified horizontal corner. *Angolare orizzontale non elettrificato*



<b>1XR5.GF1.02</b>	Bracket - Staffa	€ 8,00
--------------------	------------------	--------

3 Units to connect each linear track, or 6 units to connect two linear tracks to a singular angular (horizontal or vertical) connector.

Ordinare 3 staffe per unire due binari lineari. Ordinare 6 staffe per unire due binari lineari ad un profilo angolare (orizzontale o verticale).

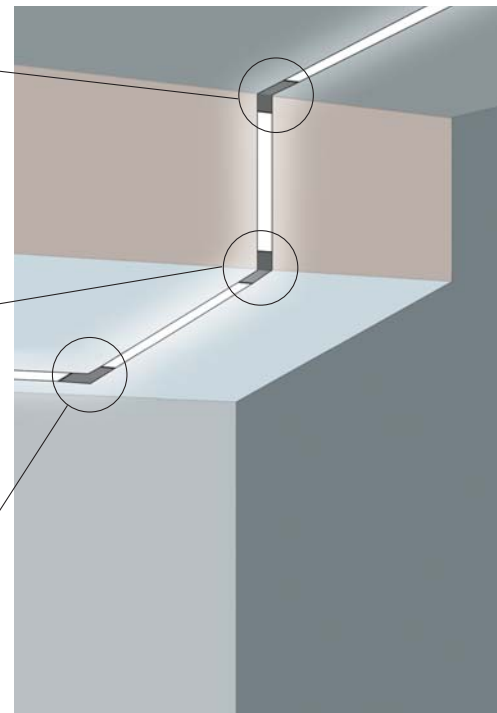
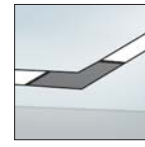
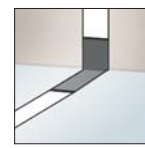

<b>1XR5.PT1.02</b>	100cm	€ 10,00
--------------------	-------	---------

Plaster installation guard. Black color

Copertura in PVC per protezione del binario durante l'installazione su cartongesso. Colore nero

Surface | Pendant - *Plafone / Sospensione*

<b>1XR2.100.02</b>	100cm	Black - Nero	€ 100,00
<b>1XR2.100.06</b>	100cm	White - Bianco	€ 100,00
<b>1XR2.200.02</b>	200cm	Black - Nero	€ 200,00
<b>1XR2.200.06</b>	200cm	White - Bianco	€ 200,00
<b>1XR2.300.02</b>	300cm	Black - Nero	€ 310,00
<b>1XR2.300.06</b>	300cm	White - Bianco	€ 310,00



<b>1XR2.GL1.01</b>	150cm	€ 40,00
<b>1XR2.GL2.01</b>	300cm	€ 42,00
<b>1XR2.GL3.01</b>	500cm	€ 51,00

Long bracket for pendant track with steel cable Ø 1,5mm  
*Staffa per binario a sospensione con cavo in acciaio Ø 1,5mm*



<b>1XR2.GAH.02</b>	Black - Nero	€ 86,00
<b>1XR2.GAH.06</b>	White - Bianco	€ 86,00

Non electrified corner for surface and pendant track  
*Angolare non elettrificato per binario a plafone e/o sospensione*

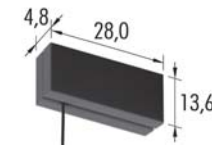

Canopy - *Rosone: On/Off 48V - 75W*

<b>3XR2.C01.02</b>	Black - Nero	€ 230,00
<b>3XR2.C01.06</b>	White - Bianco	€ 230,00

Wire - Cavo elettrificato: 150cm

<b>3XR2.C02.02</b>	Black - Nero	€ 250,00
<b>3XR2.C02.06</b>	White - Bianco	€ 250,00

Wire - Cavo elettrificato: 300cm

<b>3XR2.C03.02</b>	Black - Nero	€ 270,00
<b>3XR2.C03.06</b>	White - Bianco	€ 270,00

Wire - Cavo elettrificato: 500cm



<b>3XR2.C13.02</b>	Black - Nero	€ 125,00
<b>3XR2.C13.06</b>	White - Bianco	€ 125,00

Canopy with no device on board. Black wire 300cm  
Place the device in remote position.

*Rosone senza trasformatore. 300cm di cavo nero elettrificato. Posizionare il trasformatore in remoto.*

## Accessories for Recessed, Surface and Pendant 48V track system

Accessori comuni per binario 48V nelle versioni: incasso senza bordo, plafone e sospensione



<b>1XR.TC1.02</b>	Black - Nero	€ 8,00
<b>1XR.TC1.06</b>	White - Bianco	€ 8,00

End cup for track - *Tappo chiusura binario*



<b>1XR.TE1.02</b>	Black - Nero	€ 25,00
<b>1XR.TE1.06</b>	White - Bianco	€ 25,00

Short end - Feed - *Testata di alimetazione ridotta*



<b>1XR.TF1.02</b>	Black - Nero	€ 8,00
<b>1XR.TF1.06</b>	White - Bianco	€ 8,00

End cup with hole - *Tappo con foro per chiusura binario*



<b>1XR.GEC.02</b>	Black - Nero	€ 22,00
<b>1XR.GEC.06</b>	White - Bianco	€ 22,00

Electrified jointing connector - *Giunto passante elettrificato*



<b>1XR.CE3.02</b>	300cm. Black - Nero	€ 50,00
<b>1XR.CE3.06</b>	300cm. White - Bianco	€ 50,00

Aesthetic track cover - *Chiusura estetica binario*



<b>1XR.GEA.02</b>	Black - Nero	€ 75,00
<b>1XR.GEA.06</b>	White - Bianco	€ 75,00

Adjustable electrified corner - *Giunto elettrificato flessibile*



<b>1XR.CUT</b>	€ 181,00
----------------	----------

Cutting tool for track conductors - *Cesoia per ridurre i conduttori*



<b>1XR.GMC.02</b>	Black - Nero	€ 12,00
-------------------	--------------	---------

Non electrified jointing connector - *Giunto passante non elettrificato*

## X-Running

Pendant light made of aluminum structure with upward and downward light emission. Available in two versions:  
 - CUP, in sizes Ø60, Ø80 and Ø120cm, dimmable with central canopy Ø33cm.  
 - in sizes Ø60, Ø80, Ø120, Ø180 and Ø230cm, on/off or dimmable with micro canopy Ø7,5cm and transformer to be placed in a remote position.

Articolo a sospensione con struttura in alluminio ed emissione della luce superiore ed inferiore.

Disponibile in due versioni:

- CUP, nelle misure Ø60, Ø80 e Ø120cm, dimmerabile con rosone centrale Ø33cm.

- nelle misure Ø60, Ø80, Ø120, Ø180 e Ø230cm, on/off oppure dimmerabile con micro rosone Ø7,5cm e trasformatore da posizionare in remoto.

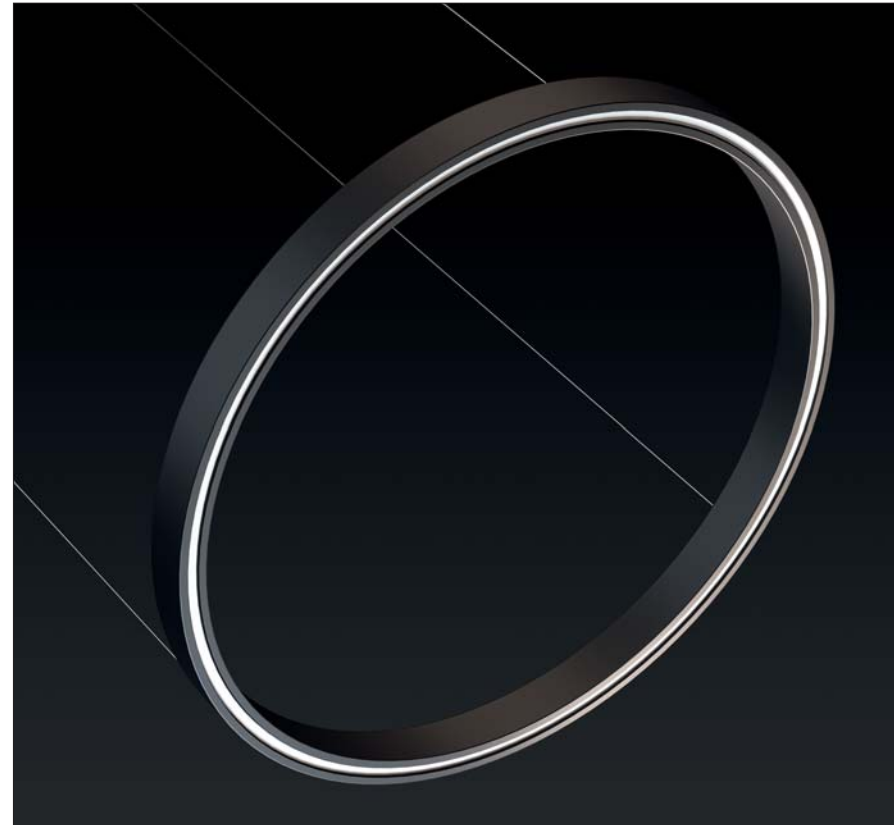

## X-Running CUP

central external canopy - rosone esterno centrale

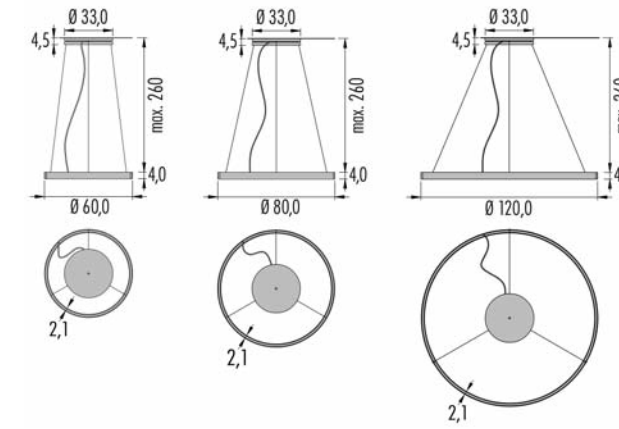

### R06 Ø 60,0

IP40	UGR<14	CE	▽	⊕
24V	<b>88W</b>	CRI>90		
<b>3RC06.4</b>	L. □	DALI - Push - 1...10V € 1.900,00		
■ Led color	Nominal lm	Beam spread		
2 = 2700K	6552	44°		
3 = 3000K	7280			

### R12 Ø 120,0

IP40	UGR<14	CE	▽	⊕
24V	<b>184W</b>	CRI>90		
<b>3RC12.4</b>	L. □	DALI - Push - 1...10V € 2.900,00		
■ Led color	Nominal lm	Beam spread		
2 = 2700K	13752	44°		
3 = 3000K	15280			

### R08 Ø 80,0

IP40	UGR<14	CE	▽	⊕
24V	<b>126W</b>	CRI>90		
<b>3RC08.4</b>	L. □	DALI - Push - 1...10V € 2.300,00		
■ Led color	Nominal lm	Beam spread		
2 = 2700K	9432	44°		
3 = 3000K	10480			

□	Ring - Anello	Canopy - Rosone	Wire - Cavo
02 ●	Black - Nero	White - Bianco	Black - Nero
06 ○	White - Bianco	White - Bianco	Black - Nero

## X - Running

micro external canopy: gear in remote position - micro rosone esterno: trasformatore in remoto

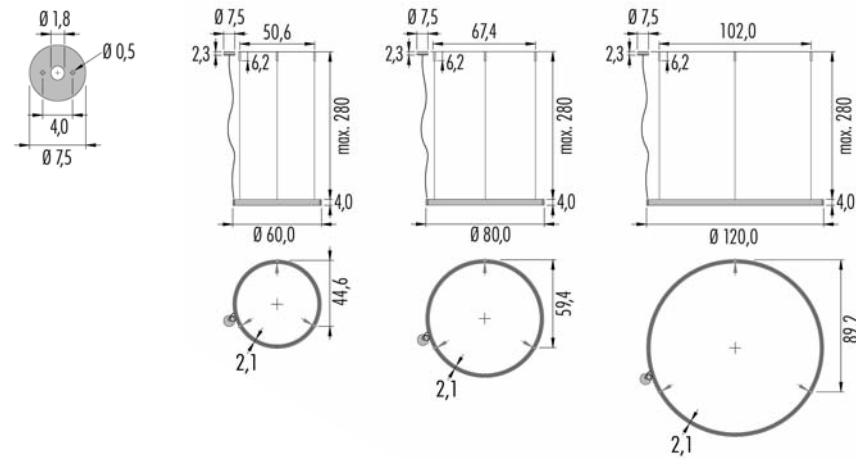

### R06 ø 60,0

IP40	UGR<14	CE	▽	⊕
24V	<b>88W</b>	CRI>90		
<b>3R06.4</b> ■ L. □	on/off	€ 1.600,00		
■ Led color	Nominal lm	Beam spread		
2 = 2700K	6552	44°		
3 = 3000K	7280			

### R12 ø 120,0

IP40	UGR<14	CE	▽	⊕
24V	<b>184W</b>	CRI>90		
<b>3R12.4</b> ■ L. □	on/off	€ 2.700,00		
■ Led color	Nominal lm	Beam spread		
2 = 2700K	13752	44°		
3 = 3000K	15280			

### R08 ø 80,0

IP40	UGR<14	CE	▽	⊕
24V	<b>126W</b>	CRI>90		
<b>3R08.4</b> ■ L. □	on/off	€ 1.900,00		
■ Led color	Nominal lm	Beam spread		
2 = 2700K	9432	44°		
3 = 3000K	10480			

□	Ring - Anello	Canopy - Rosone	Wire - Cavo
02 ●	Black - Nero	Black - Nero	Black - Nero
06 ○	White - Bianco	White - Bianco	Black - Nero

### 3KIT.E24.DIM

Dimmable option:  
DALI - Push - 1...10V  
Remote installation  
Installazione remota

€ 80,00

## X - Running

micro external canopy: gear in remote position - micro rosone esterno: trasformatore in remoto

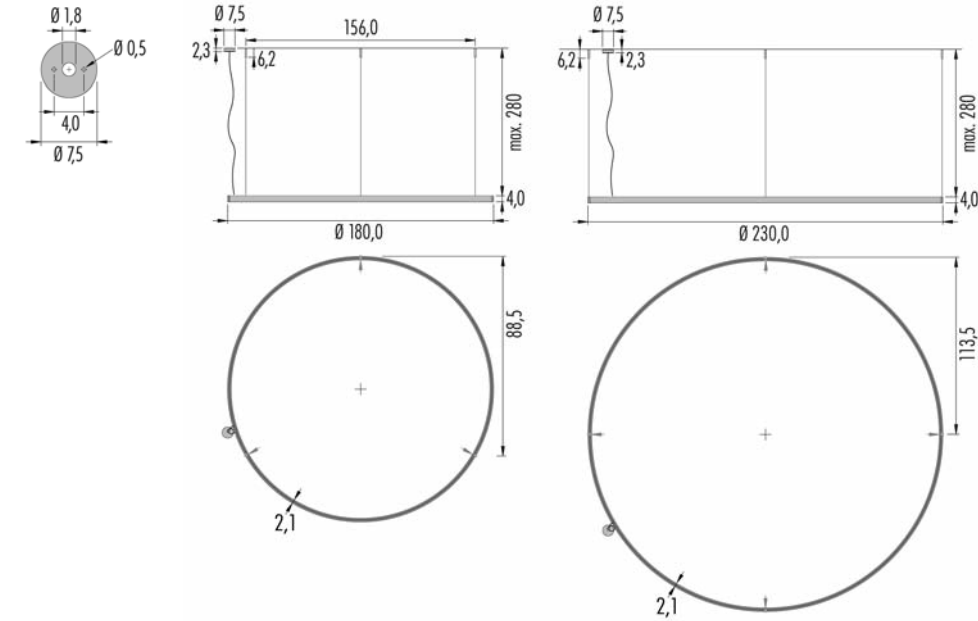

### R18 ø 180,0

IP40	UGR<14	CE	▽	⊕
24V	<b>270W</b>	CRI>90		
<b>3R18.4</b> ■ L. □	on/off - 1...10V	€ 3.700,00		
■ Led color	Nominal lm	Beam spread		
2 = 2700K	20232	44°		
3 = 3000K	22480			

### R23 ø 230,0

IP40	UGR<14	CE	▽	⊕
24V	<b>347W</b>	CRI>90		
<b>3R23.4</b> ■ L. □	on/off - 1...10V	€ 5.000,00		
■ Led color	Nominal lm	Beam spread		
2 = 2700K	26028	44°		
3 = 3000K	28920			

□	Ring - Anello	Canopy - Rosone	Wire - Cavo
02 ●	Black - Nero	Black - Nero	Black - Nero
06 ○	White - Bianco	White - Bianco	Black - Nero

### 3KIT.D24.DIM

Dimmable option:  
DALI - Push - 1...10V  
Remote installation  
Installazione remota

€ 300,00



**Z07.070.01**  
Cassaforma cartongesso

Bic B07 7x7

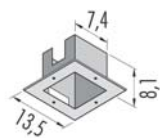

**1Z07.070.01**  
∠ 7,6cm

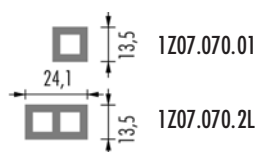

**Z12.120.01**  
Cassaforma cartongesso

Bic B12 12x12

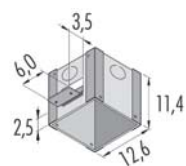

**1Z12.120.01**  
∠ 12,8cm

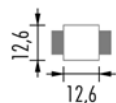

**Z00.030.01/N00.030.01**  
Cassaforma cartongesso

Pop P00 Ø 3,0

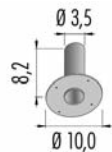

**1Z00.030.01**  
∠ Ø 4,0 cm

Pop P00 NaNo Ø 3,0

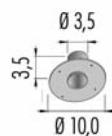

**1N00.030.01**  
∠ Ø 4,0 cm

**M00.030.01**  
Cassaforma laterizio

Pop P00 Ø 3,0

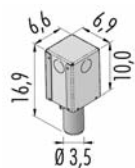

**1M00.030.01**



**Z00.040.01**  
Cassaforma cartongesso

Pop P01 Ø 4,0

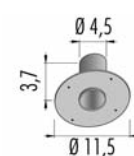

**1Z00.040.01**  
∠ Ø 5,1 cm



**Z00.055.01**  
Cassaforma cartongesso

POP P01 Ø 5,5  
POP P01 NaNo Ø 5,5  
POP P01 Bulb Ø 6,0  
POP P01 Bulb Ø 9,5  
POP P02 Ø 5,5

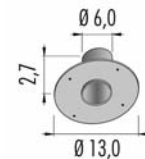

**1Z00.055.01**  
∠ Ø 6,5 cm

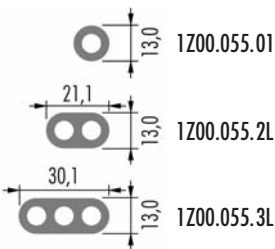

**M00.055.01**  
Cassaforma laterizio

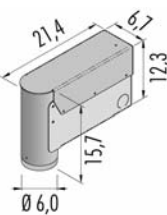

**1M00.055.01**



**Z00.060.01**  
Cassaforma cartongesso

Pop P03 Ø 6,0  
Pop P03 NaNo Ø 6,0

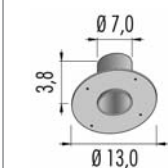

**1Z00.060.01**  
∠ Ø 7,6 cm





Pop P03 Ø 8,0

**Z00.080.01**  
Cassaforma cartongesso

**M00.080.01**  
Cassaforma laterizio

- Pop P03 Ø 8,0
- Pop P03 NaNo Ø 8,0
- Pop P04 Ø 8,0
- Pop P12 Ø 3,0

- Pop P03 Ø 8,0
- Pop P03 NaNo Ø 8,0
- Pop P12 Ø 3,0

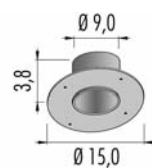

**1Z00.080.01**  
Ø 9,5 cm

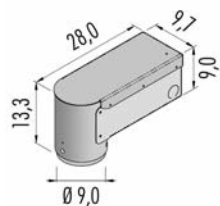

**1M00.080.01**

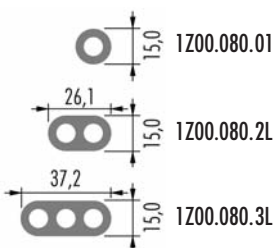

Pop PX3 Ø 10,0

**Z00.100.01**  
Cassaforma cartongesso

- Pop PX3 Ø 10,0
- Pop PX3 NaNo Ø 10,0
- Pop PY3 Ø 10,0
- Pop PY3 NaNo Ø 10,0
- Pop PZ3 Ø 10,0

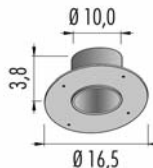

**1Z00.100.01**



Pop P12 Ø 7,0

**Z00.120.01**  
Cassaforma cartongesso

**M00.120.01**  
Cassaforma laterizio

- Pop P04 Ø 12,0
- Pop P12 Ø 7,0
- Pop P12 Ø 12,5
- Pop P122 Brooklin Arc
- Pop P202 Brooklin Arc

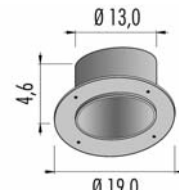

**1Z00.120.01**  
Ø 14,0 cm

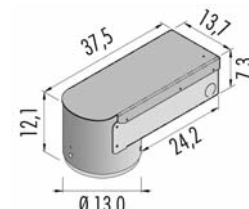

**1M00.120.01**

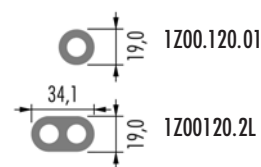

easy Pop X3 Ø 10,0

**Easy POP**  
Cassaforma laterizio

- Easy Pop P00 Ø 3,0
- Easy Pop P00 NaNo Ø 3,0
- Easy Pop P01 Ø 4,0

- Easy Pop P01 Ø 5,5
- Easy Pop P01 NaNo Ø 5,5
- Easy Pop P01 Bulb
- Easy Pop P02 Ø 5,5

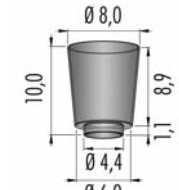

**1E00.030.01**

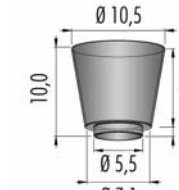

**1E00.040.01**

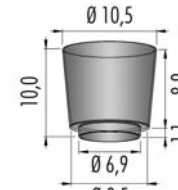

- Easy Pop P03 Ø 8,0
- Easy Pop P03 NaNo Ø 8,0
- Easy Pop P04 Ø 8,0

- Easy Pop PX3 Ø 10,0
- Easy Pop PX3 NaNo Ø 10,0
- Easy Pop PY3 Ø 10,0
- Easy Pop PY3 NaNo Ø 10,0
- Easy Pop PZ3 NaNo Ø 10,0

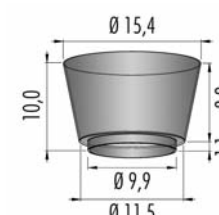

**1E00.080.01**

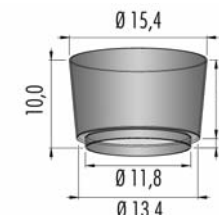

**1E00.100.01**



**W00.085.01**  
Cassaforma cartongesso

Pop P04A Magic  
Pop P04B Magic

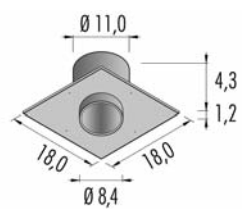

1W00.085.01



**W00.125.01**  
Cassaforma cartongesso

Pop P04C Magic  
Pop P12/L Ø 3,0

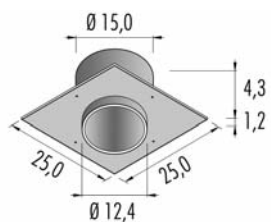

1W00.125.01



**K00.170.01**  
Cassaforma cartongesso

Pop P03 Look

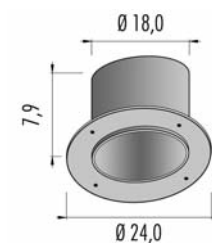

1K00.170.01  
Ø 19,0 cm



**Z00.070.01**  
Cassaforma cartongesso

Pop P10

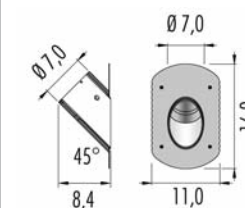

1Z00.070.01

## Vademecum

### MC-E

MacAdams step:

é un parametro attraverso il quale si definisce il grado di decadimento del colore della luce di una sorgente led nel tempo. Lo step 3 rappresenta ad oggi il livello di decadimento più basso.

it is a parameter which defines the deterioration degree of the colour of the light coming from a led source during its life. Step 3 is nowadays the lower deterioration level.

es ist ein Parameter, der der Verschlechterungsgrad der Lichtfarbe eines Led Leuchtmittels während seines Lebens bestimmt. Step 3 ist heutzutage das niedrigste Verschlechterungsniveau.

Est un paramètre avec le quel on défini le degré de détérioration de la couleur de la lumière d'une source led dans le temps. Aujourd'hui le Step 3 est le niveau de détérioration le plus bas.

el es un parámetro que define el grado de deterioración del color de la luz de una fuente led en el tiempo. El step 3 representa hoy el nivel de deterioración más bajo.

### CRI

Indice di resa cromatica di una sorgente luminosa, e misura di quanto naturali appaiano i colori degli oggetti da essa illuminati.

Colour Rendering Index of a light source and measure indicating how natural the colours of objects appear when enlightened from it.

Farbwiedergabeindex einer Lichtquelle und Maß, das, wie nach der Natur die Farben der Objekten sich herausstellen, wenn sie von dieser Lichtquelle beleuchtet sind, anzeigt.

Indice de rendu des couleurs d'une source lumineuse et mesure qui indique la pureté des couleurs des objets éclairés par cette source.

Indice de rendimiento lumínico de una fuente luminosa, y medida de lo natural del color de los objetos iluminados con dicha fuente.

### lm

Il lumen è l'unità di misura del flusso luminoso di una sorgente luminosa. Lumen is the unit of the light flux of a light source.

Lumen ist ein Maß der Strahlengang einer Lichtquelle.

Le lumen est l'unité de mesure du flux d'éclairage d'une source lumineuse.

El lumen es la unidad de medida del flujo luminoso de una fuente luminosa.

### lx

Il lux è l'unità di misura per l'illuminamento di un'area piana. Un lux è pari a un lumen fratto un metro quadrato.

Lux is the unit for the lighting of a flat area. One lux is equal to one lumen divided per one square meter.

Lux ist ein Maß für die Beleuchtung einer ebenen Oberfläche. Ein lux ist gleich ein lumen geteilt durch einen quadratischen Meter.

Le lux est l'unité de mesure pour l'illumination d'une zone plane. Un lux correspond à un lumen divisé par mètre carré.

El lux es la unidad de medida de iluminación de una superficie. Un lux es equivalente a un lumen por metro cuadrado.



Classe I: Le componenti elettriche accessibili sono collegate ad un conduttore di terra.

Class I: Only basic insulation, accessible conductors are earthed. Earthing compulsory.

Klasse I: Grundisolation leitenden; berührbare Metallteile sind mit Schutzerdung verbunden. Schtzerdung vorgeschrieben.

Class I: Seulement isolation de base, les parties conductrices accessibles sont reliées à un conducteur terre.

Mise à la terre obligatoire.

Clase I: Sólo aislamiento fundamental; además, las partes conductoras accesibles están conectados a un conductor de tierra. Puesta a tierra indispensable.



Classe II: Messa a terra esclusa, sostituita da cavi elettrici con un isolamento rinforzato.

Class II: basic insulation plus second insulation or both are replaced by reinforced insulation. Earthing excluded

Klasse II: Entweder zu der Grundisolierung kommt noch eine zweite Isolierung hinzu oder ist eine verstrebtten Isolierung vorgesehen.

Class II: Soit à l'isolation, soit ces deux dernières sont remplacées par une isolation renforcée.

Mise à la terre: excluse.

Clase II: Al aislamiento fundamental se añade un segundo aislamiento, o bien los dos aislamientos se reemplazan por un aislamiento reforzado.



Classe III: Alimentazione a bassa tensione, inferiore a 50V-50Hz. Messa a terra non prevista.

Class III: Low tension inferior to 50V-50Hz. No ground cable.

Klasse III: Niedervolt < 50V-50 HZ, ohne Erdung

Class III: Alimentation de sécurité à basse tension.

Ne doit en aucun cas être utilisée pour des tensions supérieures à 50V-50Hz. mise à la terre.

Clase III: Alimentación de baja tensión, inferior a 50V-50Hz. Toma de tierra no prevista.



Apparecchio con caratteristiche per il montaggio diretto su superfici normalmente infiammabili (EN 60 598/VDE 0711).

Device which can be mounted on flammable surfaces (EN 60 598/VDE 0711).

Aparato con características para el montaje directo sobre superficies normalmente inflamables (EN 60 598/VDE 0711).



Prodotto conforme alle direttive europee.

Products complying with the Eur. Comm. rules.

Produkt gemaess den EU-Normen.

Producido conforme a las directivas europeas.

## IP identification



Driver incluso  
Driver included  
Treiber mitgeliefert  
Driver fourni  
Driver incluido



Driver non incluso  
Driver not included  
Treiber nicht mitgeliefert  
Driver non fourni  
Driver excluido



lampadina inclusa  
including bulb  
Leuchtmittel inklusiv  
ampoule comprise  
bombilla incluida



trasformatore incluso  
transformer included  
Trafo mitgeliefert  
transformateur fourni  
transformador incluido



trasformatore non incluso  
transformer not included  
Trafo nicht mitgeliefert  
transformateur non fourni  
transformador excluido



Articolo: fine esaurimento scorta.  
Item: Run Out of Stock



nessuna protezione  
no protection  
kein Schutz  
non protégé  
sin protección



protezione contro corpi estranei ≥ 50mm  
protection against solid objects ≥ 50mm  
Schutz gegen Fremdkörpern ≥ 50mm  
protection contre des corps étrangers ≥ 50mm  
protegido contra objetos extraños ≥ 50mm



protezione contro corpi estranei ≥ 12mm  
protection against solid objects ≥ 12mm  
Schutz gegen Fremdkörpern ≥ 12 mm  
protection contre des corps étrangers ≥ 12mm  
protegido contra objetos extraños ≥ 12mm



protezione contro corpi estranei ≥ 2,5mm  
protection against solid objects ≥ 2,5mm  
Schutz gegen Fremdkörpern ≥ 2,5mm  
protection contre des corps étrangers ≥ 2,5mm  
protegido contra objetos extraños ≥ 2,5mm



protezione contro corpi estranei ≥ 1mm  
protection against solid objects ≥ 1mm  
Schutz gegen Fremdkörpern ≥ 1mm  
protection contre des corps étrangers ≥ 1mm  
protegido contra objetos extraños ≥ 1mm



protezione da polvere  
dust-protected  
Staubgeschützt  
protection contre la poussière  
aparato protegido contra el polvo



stagno alla polvere  
dust-proof  
Staubdicht  
hermétique à la poussière  
aparato totalmente protegido contra el polvo



nessuna protezione  
no protection  
kein Schutz  
non protégé  
sin protección



protezione contro caduta acqua verticale  
protected against water drops falling vertically  
Schutz gegen Wassertropfen, die senkrecht herabfallen  
protégé contre les gouttes d'eau tombant verticalement  
protegido contra la caída de gotas de agua



protezione contro caduta di gocce oblique a 15°  
protected against water drops max inclination 15°  
Schutz gegen Wassertropfen, die senkrecht herabfallen Neigung 15°  
protégé contre les gouttes d'eau à inclinaison maximale de max 15°  
protegido contra la caída de gotas de agua con inclinación max 15°



protezione contro caduta di gocce oblique a 60°  
protected against water drops max inclination 60°  
Schutz gegen Wassertropfen, die senkrecht herabfallen Neigung 60°  
protégé contre les gouttes d'eau à inclinaison de max 60°  
protegido contra la caída de gotas de agua con inclinación max 60°



protezione contro spruzzi d'acqua  
protected against sprinkling water  
Spritzwassergeschützt  
protégé contre les éclaboussures  
aparato protegido contralas salpicaduras



protezione contro getti d'acqua  
protected against water jets  
Wasserstrahlgeschützt  
protégé contre les gouttes d'eau  
aparato totalmente protegido contra los chorros de agua



protezione contro inondazioni  
Potected against flooding  
Überschwemmunggeschützt  
rotected against flooding  
aparato totalmente protegido contra



protezione per immersione temporanea  
protected against brief immersions  
gegen kurzen Tauchen geschützt  
hermétique à la immersion  
aparato totalmente protegido contra la sumersión



protezione per immersione costante  
protected against long immersion  
Tauchengeschützt  
protégé pour des immersions prolongées  
aparato totalmente protegido contra la larga imersión

## General Sales Terms

### 1- Invalidity of the General Sales Terms and of the Price Lists previously in force

1.1 All the sales and payment terms previously in force are expressly cancelled and replaced by the following general sales terms, as the present price list cancels and replaces each previous edition; both are **valid since 15<sup>th</sup>/10/2021** and they could be updated or modified at any time, giving notice if necessary through the pages of the web site [www.otylight.com](http://www.otylight.com)

### 2- Application and acceptance of the General Sales Terms:

2.1 The business relationships between Oty srl and its customers are exclusively regulated by the following general sales terms, with express renunciation and exclusion of any other agreement.

2.2 Sending an order to Oty srl, the customer declares to have gone through all the information given to him and to accept entirely, without any reservation, all the following general sales terms, which must be considered as an integral and substantial part of the sales contract.

2.3 The contract will be valid only once the customer's order is approved in writing by Oty srl. The parties could agree on possible changes, integrations or derogations to the above mentioned general sales terms, which should appear in writing in the documents including the order of the purchaser and the relating express acceptance of the seller in the order confirmation. The exclusions or the modifications introduced by the customer, if not expressly confirmed in written by Oty srl, do not bind Oty and do not become integral part of the contract, even if they have not been expressly refused and/or challenged. In any case the missing answer does not mean acceptance.

2.4 The customer is not entitled to damages and it is excluded any contractual or extra-contractual responsibility for direct or indirect damages to persons and/or things, caused by the missing acceptance, even if partial, of an order.

### 3- Presentation of the products:

3.1 Oty srl improves constantly its products and therefore reserves the right to introduce the necessary changes or updating at its exclusive discretion at any time. For this reason the products' technical and dimensional information (instructions for use, drawings, illustrations, technical data, weight, measure and performances descriptions) written in brochures, catalogues, newsletters, advertisements and in price lists are not binding if not expressly specified in the order confirmation, and could be subject to modifications or updating without any advance notice.

### 4- Offers and Prices:

4.1 All prices written in the price list are expressed in EURO, not including VAT.

4.2 These prices could be modified at any time at Oty srl exclusive discretion and with no obligation of any advance notice or communication.

4.3 Prices do not include light bulbs, if not differently and previously specified in written between the parties.

4.4 The offers of Oty srl and the customers' orders must be always considered "except for availability and prices changes".

### 5- Orders:

5.1 Each Order sent to Oty srl must be considered as a definitive and binding proposal for the purchaser, and this could be cancelled or modified only through a written agreement between the parties.

Anyway, the orders for customized products or for products different from standard Oty light's product, could not be cancelled neither totally nor partially once they have been sent to Oty srl.

5.2 After receiving the order Oty srl is not obliged to communicate to the customer that the net value of the above mentioned order, since it is lower than the free port limit, implies the non-application of the under mentioned delivery "free port" clause.

5.3 In case of integration orders or anyway of orders linked to the previous ones, Oty do not guarantee the delivery of the same tone or design of the material previously delivered.

### 6- Delivery

6.1 The delivery terms indicated on the orders' confirmations or verbally agreed between the parties, have only an indicative value. Their non-observance, as also the possible delivery of partial or reduced supplies, will not cause either the cancellation of the relating order or the application of any fine or the acknowledgment of any kind of compensation.

### 7- Packaging:

7.1 The products are provided packed in boxes of recyclable carton, whose cost is included in the price.

### 8- Pick up of the goods:

8.1 The ordered and supplied goods must be regularly picked up by the customer. If Oty srl will not be responsible for the non-delivery or if the customer refuses the delivery of the goods, the customer himself will have to organize on his own, at his own expenses and on Oty written exhortation the pick up of the previously mentioned goods, which is the object of the contract, within the deadline communicated by Oty srl and, in addition, the customer will have to pay the price of the goods. Once this expiry date is passed uselessly, Oty srl is free from any responsibility and is authorized to issue an additional regular invoice for interests on arrears (ex D.Lgs 231/2002) accrued on capital and for goods storage costs and any further damage.

8.2 At the moment of the goods delivery by the forwarder, the customer has to make all the necessary controls to check the possible damages, missing pieces, defects or other apparent imperfections of the delivered goods in comparison to the order. Precisely he must control that:

8.2.1 The number of the delivered items corresponds to the number indicated in the delivery note.

8.2.2 The packaging is integral, not damaged, not wet or anyway altered, also the closing materials. Possible damages to the packaging and/or the goods, or the non-correspondence of the number of items or of the indications, must be immediately notified, writing "reservation of control" (and specifying the cause of this reservation) on the delivery note of the forwarder and also confirmed, writing the raised reservations in a recorded delivery letter with receipt of return to Oty srl. Once the delivery note of the forwarder has been signed, the customer could not complain anymore about the external peculiarities of the delivered goods.

### 9- Installation:

9.1 The installation and the connection/assembly of the goods, object of the supply, are at the customer's expenses and management.

All the products must be connected and installed according to the **C€** laws, or anyway to those in force, and according to the information contained in the catalogue and in the instruction sheets by skilled and expert personnel. Oty srl declines every responsibility for products sold and/or installed in countries in which there are laws that do not allow their use.

### 10- Returned goods:

10.1 Returned goods will be accepted only after written authorization by Oty srl and only if the product will be returned with all its original parts (including the possible documentation and accessories: instruction manuals, cables, etc...), in the original packaging, and within 7 days since the authorization. If just one of these requirements will be missing, Oty srl will return the goods to the sender ex factory. In any case, returned goods are considered free of port to Oty srl seat.

10.2 Except for any different instruction, the material will be credited only if it could be resold by Oty srl, net of costs for the control and restoring of it.

10.3 Anyway all the special productions, customized or produced according to the customer's specifications, or anyway different from standard Oty light product, as also the feeders/ballasts and housings for recessed items, could not be returned or refused.

### 11- Complaints:

11.1 Possible problems concerning the integrity, the correspondence or the completeness of the received goods, or any claim concerning manufacturing and/or quality defects of the goods must be notified in written, otherwise invalid, to Oty within 8 (eight) days since the date of the receipt of the goods (in case of apparent defects and/or imperfections) or since the discovery (in case of non-visible defects and/or defects).

Once this term is expired, no complain will be accepted.

11.2 For the approval of the complaint, the customer will have to demonstrate the correct maintenance and, if necessary, the correct installation of the product.

11.3 Possible claims or complaints, notified either bringing an action or raising an objection, will not allow the suspension of the goods' payments.

11.4 If the complaints will result groundless, Oty srl will debit the expenses paid for possible controls on the spot and also the costs and charges for possible surveys even if made by a third part.

### 12- Guarantee:

12.1 Oty product is made and controlled according to the **C€** laws, which guarantee the security and the technical quality of the materials.

12.2 Each Oty product has the guarantee foreseen by the laws in force since the delivery date of the goods, and by the way, the guarantee is limited to the items considered faulty and anyway to a maximum amount equal to the one of the bought goods. In any case Oty srl will not be obliged to compensate the customer for direct or indirect damages or for any other financial damage suffered by buyer or by a third part.

12.3 To benefit from assistance under guarantee, the customer must show the original invoice (or delivery note) and/or receipt for fiscal purposes.

12.4 The guarantee is applied to Oty product, if and only if, it is used correctly, according to its main use and to what is foreseen in the technical instructions attached.

12.5 It is excluded from the guarantee each defect of the product caused by a wrong installation, storage, maintenance, connection or assembling (non-observance of the **C€** laws in force and of the information written in the catalogue and in the possible assembling and instructions sheets), by a faulty servicing, by a wrong use or by a use not according to the technical or employment specifications (non-observance of the servicing and maintenance instructions and of the use conditions), by modifications or repairs, made by the customer or by a third part, by deteriorations or damages caused by external objects or events (such as incidents, blows, fires, acts of vandalism, water loss from pipes, natural or artificial lights (in case of discoloration), bad weather.

12.6 Products which have been tampered with or anyway damaged because of overloads, high or low voltage, unexpected chemical electrochemical/electrical alterations or because of a third party in general have no guarantee.

12.7 During the guarantee period, Oty srl commits itself, at its sole discretion, to substitute or repair the products or the products' pieces which Oty recognizes as faulty, or to reduce or pay back the corresponding price. Possible invoices for repairs made by a third part will not be in any case refunded by Oty srl.

12.8 If required, the customer will have to prove the defect with pictures which must be sent to Oty's e-mail address [info@otylight.com](mailto:info@otylight.com).

### 13- Payment terms:

13.1 Except for any different instruction agreed in written between the parties, the supplies must be paid cash on delivery.

13.2 The payment must be made exclusively in Euro.

13.3 The customer does not have the right to counterbalance his debts towards Oty with his own possible credits or opposite demands. The customer could not raise any kind of objection to avoid or delay the payment of the required price.

13.4 In case of delayed payments, the customer must pay to Oty srl the interests on arrears (ex D.Lgs 231/2002), since the fixed expiry payment term. Possible discounts or allowances will decay.

13.5 In addition to what specified in the previous point, if the customer will not pay, even a part of the price, within the fixed expiry term, he will lose the benefit of the postponed payment ("benefit of the term"), also for the existing supplies; Oty srl could appeal to the application of articles no.1460 and 1461 of the Italian Civil Code and therefore suspend the ongoing supplies.

### 14- Withdrawal of the contract

14.1 Oty srl has the power to withdraw from the contract, with no charges, if it will know about the existence of protests as also the beginning of judicial (commanding decree) or extrajudicial processes against the client.

### 15- Renounce to recourse

15.1 Oty srl does not recognize to the customer the right of recourse (ex art. 131 D. Lgs: 06/09/2005, n. 206 and following modifications).

### 16- Applicable law and competent court:

16.1 The sales contract is regulated by the Italian law and it is excluded the application of any other international law or convention.

16.2 Considering the possible application of mandatory regulations, for any dispute related to the interpretation, application, execution of the sales contract and/or to the present "general sales terms" or anyhow related to them, the exclusive competent court will be Treviso.

### Specific approval:

The customer/purchaser sending an order to Oty srl, admits and clearly confirms to have gone through and, according to the art. 1341 and 1342 C.C., and after reading, to accept and approve integrally and without reserve the above mentioned General Sales Terms, written also in the web site ([www.otylight.com](http://www.otylight.com)), which must be considered as an integral and substantial part of the sales contract and, in particular, the following articles:

- 1) Invalidity of the General Sales Terms and of the Price lists previously in force;
- 2) Application and acceptance of the General Sales Terms;
- 4) Offers and Prices;
- 5) Orders;
- 6) Delivery;
- 8) Pick up of the goods;
- 9) Installation of the product;
- 10) Returned goods;
- 11) Complaints;
- 12) Guarantee;
- 13) Payment terms;
- 14) Withdrawal of the contract;
- 15) Renounce to recourse;
- 16) Applicable law and competent court.

## Condizioni generali di vendita

**1- Invalidità delle Condizioni Generali di Vendita e dei Listini Prezzi previgenti**

1.1 Tutte le previgenti condizioni di vendita e di pagamento sono espressamente annullate e sostituite dalle seguenti condizioni generali di vendita, così come il presente listino prezzi annulla e sostituisce ogni precedente edizione; entrambi hanno **validità dal giorno 15/10/2021** e potranno essere aggiornati o modificati in qualsiasi momento, dandone eventualmente notizia tramite le pagine del sito www.otylight.com

**2- Applicazione e accettazione delle Condizioni generali di vendita:**

2.1 I rapporti commerciali tra Oty srl ed i suoi Clienti sono regolati esclusivamente dalle seguenti Condizioni Generali di Vendita, con espressa rinuncia ed esclusione di qualsiasi altra pattuizione.

2.2 Con l’effettuazione di un ordine a Oty srl il Cliente dichiara di aver preso visione di tutte le indicazioni a lui fornite e di accettare integralmente le Condizioni Generali di Vendita di seguito illustrate, senza riserva alcuna, che devono ritenersi parte integrante e sostanziale del contratto di compravendita

2.3 Il contratto deve intendersi perfezionato allorchè l’ordine del Cliente sia stato confermato per iscritto dalla Oty srl. Le parti potranno concordare eventuali modifiche, integrazioni o deroghe alle summenzionate C.G. di V., che dovranno risultare per iscritto dai documenti contenenti l’ordine della parte acquirente e la relativa espressa accettazione della parte venditrice nella conferma d’ordine.

Le esclusioni o le modifiche apportate dal Cliente, se non espressamente confermate per iscritto dalla Oty srl, non vincolano quest’ultima e non formano parte integrante del contratto, anche se non sono state espressamente rifiutate e/o contestate.

In ogni caso la mancata risposta non significa consenso.

2.4 Viene escluso ogni diritto del Cliente ad un risarcimento danni o indennizzo, nonché qualsiasi responsabilità contrattuale o extracontrattuale per danni diretti o indiretti a persone e/o cose, provocati dalla mancata accettazione, anche parziale, di un ordine.

**3- Presentazione dei prodotti:**

3.1 Oty srl migliora costantemente i propri prodotti, pertanto si riserva la facoltà di apportare le modifiche o gli adeguamenti che ritiene opportuni, in qualsiasi momento, a propria esclusiva discrezione. Per questo motivo, le informazioni tecniche e dimensionali dei prodotti (Indicazioni, disegni, immagini, dati tecnici, descrizioni di peso, misure e prestazioni) riportate in depliant, cataloghi, circolari, annunci e nel listino prezzi non sono vincolanti se non esplicitamente specificati come tali nella conferma d’ordine, e potranno essere soggette a modificazioni o adeguamenti, anche senza preavviso alcuno.

**4- Offerte e Prezzi:**

4.1 Tutti i prezzi indicati nel listino di vendita sono espressi in EURO, al netto di IVA, calcolata separatamente in base all’aliquota di legge.

4.2 Tali prezzi possono essere modificati in qualsiasi momento, a discrezione esclusiva di Oty srl e senza obbligo di alcun preavviso o comunicazione.

4.3 I prezzi non comprendono le lampadine, salvo se diversamente e previamente specificato per iscritto tra le parti.

4.4 Le offerte di Oty srl, e gli ordini dei Clienti devono sempre intendersi “salvo disponibilità” e “salvo modifiche dei prezzi”.

**5- Ordini:**

5.1 Ogni Ordine trasmesso a Oty srl è da intendersi come proposta irrevocabile e vincolante per la parte committente, e potrà essere annullato o modificato soltanto tramite accordo scritto tra le parti. In ogni caso, gli ordini di prodotti speciali, o comunque diversi dal prodotto standard Oty light, una volta trasmessi a Oty srl non potranno essere annullati, né totalmente né parzialmente.

5.2 A seguito del ricevimento dell’ordine, Oty srl non ha alcun obbligo di comunicare al Cliente che il valore netto del predetto ordine, in quanto inferiore ad € 260,00, comporta la non applicazione della sotto riportata clausola di consegna “porto franco”.

5.3 Nel caso di ordini di completamento o comunque collegati a precedenti ordini, non viene garantita la fornitura dell’esatta tonalità o disegno del materiale consegnato in precedenza.

**6- Consegna:**

6.1 Per ogni singolo ordine del valore netto pari o superiore ad € 260,00=

il relativo trasporto avverrà franco Cliente (“porto franco”)

6.2 Per ogni singolo ordine del valore inferiore ad € 260,00= saranno addebitate

le spese di trasporto come di seguito indicate:

6.2.1 – per le consegne in Piemonte, Valle d’Aosta, Liguria, Lombardia, Veneto, Friuli Venezia Giulia, Trentino Alto Adige: € 15,00= ;

6.2.2 – per le consegne in Emilia Romagna, Toscana, Marche, Umbria, Lazio: € 18,00;

6.2.3 – per le consegne in Abruzzo, Molise, Campania, Puglia, Basilicata, Calabria, Sicilia, Sardegna: € 20,00

6.3 I termini di consegna indicati sulle conferme d’ordine, o verbalmente concordati tra le parti, hanno mero valore orientativo. La loro mancata osservazione, così come l’eventuale consegna di forniture parziali o ridotte, non daranno luogo all’annullamento dell’ordine relativo, né all’applicazione di penali o al riconoscimento di qualsivoglia risarcimento danni di qualsiasi natura o ad indennizzi di alcun genere.

6.4 In deroga a quanto previsto al punto 6.1 e in aggiunta a quanto indicato al punto 6.2, saranno addebitati in fattura, per un importo comunque non inferiore ad € 10,00=, i costi e le spese di ogni consegna da eseguirsi secondo le seguenti caratteristiche:

- in cantieri in costruzione, in abitazioni di Clienti privati o comunque a destinatari con indirizzo diverso dal magazzino del Rivenditore;

- su appuntamento o previa telefonata del trasportatore;

**7- Imballo:**

7.1 I prodotti sono forniti imballati in scatole di cartone riciclabile, con costo compreso nel prezzo.

**8- Ritiro della merce:**

8.1 La merce ordinata e fornita dovrà essere regolarmente ritirata dal Cliente. Qualora la consegna non sia avvenuta per fatto non imputabile a Oty srl o il Cliente rifiuti la consegna della merce, quest’ultimo dovrà provvedere, a sua cura e spese, e su invito scritto di Oty srl, a ritirare la predetta merce oggetto di contratto entro il termine comunicato dalla Oty srl e dovrà, altresì, provvedere al pagamento del prezzo della merce. Trascorso inutilmente il predetto termine, Oty srl è liberata da ogni responsabilità ed è autorizzata ad emettere ulteriore regolare fattura di addebito per gli interessi di mora commerciali (ex D.Lgs. 231/2002) maturati sul capitale e per le spese di stoccaggio della merce, fatto salvo ogni maggiore danno.
8.2 Al momento della consegna della merce da parte del corriere, il Cliente deve procedere a tutte le verifiche necessarie per rilevare le eventuali avarie, mancanze, difetti, altri vizi apparenti dei prodotti consegnati rispetto all’ordine. In particolare, è tenuto a controllare:

8.2.1 Che il numero dei colli in consegna corrisponda a quanto indicato nel documento di trasporto;

8.2.2 Che l’imballo risulti integro, non danneggiato, né bagnato o comunque alterato, anche nei materiali di chiusura.

Eventuali danni all’imballo e/o al prodotto o la mancata corrispondenza del numero dei colli o delle indicazioni, devono essere immediatamente contestati, apponendo “riserva di controllo scritta”(e specificando il motivo della riserva) sulla prova di consegna del corriere, e confermati, riportando le riserve sollevate, mediante raccomandata con ricevuta di ritorno, alla Oty srl. Una volta firmato il documento del corriere, il Cliente non potrà opporre alcuna contestazione circa le caratteristiche esteriori di quanto consegnato.

**9- Installazione:**

9.1 l’installazione e il collegamento/montaggio dei prodotti oggetto di fornitura sono effettuati a cura e spese del Cliente. Tutti i prodotti debbono essere collegati ed installati secondo le norme **C€** o comunque in vigore e le informazioni contenute nel catalogo e sugli eventuali fogli di istruzione da parte di personale addestrato e competente. Oty srl declina ogni responsabilità per prodotti commercializzati e/o installati in Paesi in cui vi siano norme che non ne consentano l’impiego.

**10- Resi di materiale:**

10.1 Resi di prodotto verranno accettati solamente previa autorizzazione scritta di Oty srl e solamente se il prodotto verrà restituito completo di tutte le sue parti originali (compresa eventuale documentazione e dotazione accessoria: manuali, cavi, ecc.), nell’imballo originale, ed entro 7 giorni dall’autorizzazione.

In assenza di anche uno solo di tali requisiti, Oty srl respingerà la merce al mittente in porto assegnato. In ogni caso, i resi si intendono franco Oty srl, presso la sua sede.

10.2 Salvo diverse disposizioni, il materiale verrà accreditato solo se rivendibile dalla Oty srl, al netto delle spese sostenute per il controllo e ripristino del materiale stesso.

10.3 In ogni caso, non potranno essere oggetto di reso e di recesso, tutte le produzioni speciali, personalizzate o fabbricate secondo le specifiche del Cliente, o comunque diverse dal prodotto standard Oty light, nonché gli alimentatori/reactori e le casseforme per articoli ad incasso.

**11 Reclami:**

11.1 Eventuali problemi inerenti l’integrità materiale, la corrispondenza o la completezza dei prodotti ricevuti, ovvero qualsiasi reclamo per vizi di fabbricazione e/o difetti di qualità della merce dovranno essere segnalati a Oty srl per iscritto, a pena di decadenza, entro 8 (otto) giorni dalla data di ricevimento dei prodotti (in caso di vizi e/o difetti apparenti) o dalla scoperta (in caso di vizi e/o difetti occulti). Scaduto tale termine non sarà accettato alcun reclamo.

11.2 Il Cliente dovrà dimostrare, per l’ammissibilità del reclamo, la corretta conservazione nonché l’eventuale corretta installazione del prodotto.

11.3 Eventuali reclami o contestazioni, sollevati sia in via d’azione che di eccezione, non daranno diritto alla sospensione dei pagamenti dei prodotti.

11.4 Qualora le contestazioni risultino infondate, la Oty srl addebiterà le spese sostenute per gli eventuali sopralluoghi e i costi ed oneri di eventuali perizie anche di terzi.

**12 Garanzia:**

12.1 Il prodotto Oty è costruito e controllato secondo le normative **C€**, che garantiscono la sicurezza e la qualità tecnica dei materiali.

12.2 Ogni prodotto di Oty srl è coperto dalla garanzia prevista dalla norme di legge in vigore, a decorrere dalla data di consegna, che, in ogni caso, è limitata ai pezzi ritenuti difettosi e, comunque, ad un valore massimo pari a quello del prodotto compravenduto. Oty srl non sarà in alcun caso tenuta al risarcimento di danni diretti o indiretti o a qualsiasi altro pregiudizio finanziario subito dall’acquirente o da un terzo.

12.3 Per fruire dell’assistenza in garanzia, il Cliente dovrà presentare l’originale della fattura (o il DDT) e/o dello scontrino fiscale.

12.4 La garanzia si applica al prodotto Oty purchè il prodotto stesso sia utilizzato correttamente, nel rispetto della sua destinazione d’uso e di quanto previsto dalla documentazione tecnica allegata.

12.5 È escluso dalla garanzia qualsiasi difetto del prodotto che possa risultare da errata installazione, immagazzinamento, conservazione, collegamento o montaggio (mancato rispetto delle normative **C€** in vigore e delle informazioni contenute nel catalogo e sugli eventuali fogli di istruzioni, anche di montaggio), da un difetto di manutenzione, cattivo utilizzo o uso non conforme alle specifiche tecniche o di utilizzo (mancato rispetto delle prescrizioni di manutenzione e mantenimento e delle condizioni d’impiego), modifiche o riparazioni effettuate dal Cliente o da un terzo, deterioramenti o danni causati da oggetti esterni o eventi esterni - quali incidenti, colpi, incendi, atti di vandalismo, perdita da tubature, luci naturali o artificiali (in caso di decolorazione), intemperie -.

12.6 La garanzia è inoltre esclusa e non copre i prodotti che risultano manomessi o comunque danneggiati per sovraccarichi, tensioni di rete, alterazioni chimiche, elettrochimiche o elettriche non previste; o per colpa di terzi in genere.

12.7 Durante il periodo di garanzia, Oty srl si impegna, a sua esclusiva discrezione, a sostituire o riparare i prodotti o le parti dei prodotti da lei stessa riconosciuti/e difettosi/e, ovvero a ridurre o rimborsare il corrispondente prezzo. Eventuali fatture per riparazioni effettuati da terzi, non saranno in alcun modo rimborsate da Oty srl.

12.8 Se richiesto, il Cliente dovrà documentare il difetto tramite materiale fotografico all’indirizzo di posta elettronica info@otylight.com.

**13 Condizioni di pagamento:**

13.1 Salvo diverse disposizioni concordate tra le parti per iscritto, le forniture devono essere pagate per contrassegno.

13.2 Il pagamento deve essere effettuato esclusivamente in Euro.

13.3 Il Cliente non ha diritto di compensare i propri debiti verso Oty srl con eventuali suoi crediti o contro pretese. Il Cliente non potrà opporre alcuna eccezioni, di qualsivoglia genere o natura, al fine di evitare o ritardare il pagamento del prezzo dovuto.

13.4 Nel caso di pagamenti effettuati in ritardo, il Cliente deve corrispondere ad Oty srl gli interessi di mora ex D.Lgs. 231/2002, a decorrere dalla data di scadenza del termine convenuto. Eventuali sconti o abbuoni decadranno.

13.5 Fermo quanto previsto dalla clausola che precede, nel caso di mancato pagamento alla prevista scadenza anche di una sola parte del prezzo, il Cliente decadrà dal beneficio della dilazione dei pagamenti (“beneficio del termine”) anche per le forniture in corso; la Oty srl potrà invocare l’applicazione degli articoli 1460 e 1461 del Codice Civile e quindi sospendere le forniture in corso.

**14 Recesso dal contratto:**

14.1 Oty srl avrà facoltà di recedere dal contratto, senza alcun onere, qualora venga a conoscenza dell’esistenza di protesti di titoli, nonché dell’avvio di procedure giudiziarie monitorie, ordinarie, concorsuali anche extragiudiziarie a carico del Cliente.

**15 Rinuncia al regresso**

15.1 La Oty srl non riconosce al Cliente il diritto di regresso ex art. 131 D.Lgs: 06/9/2005, n. 206 e successive modifiche.

**16 Diritto applicabile e Foro competente:**

16.1 Il contratto di vendita è regolato dal diritto italiano ed è esclusa l’applicazione di qualsiasi altro diritto o convenzione internazionale.

16.2 Fermo restando l’eventuale applicabilità di disposizioni inderogabili di legge, qualsiasi controversia derivante dalla interpretazione, applicazione, esecuzione del contratto di vendita e/o dalle presenti “condizioni generali di vendita” o comunque ad essi riferibile, verrà devoluta in via esclusiva alla competenza del Foro di Treviso.

Oty light 119

Oty light 119

Oty light 119

Oty light 119

Oty light 119

Oty light 119

Oty light 119

Oty light 119

Oty light 119

Oty light 119

Oty light 119

Oty light 119

Oty light 119

Oty light 119

Oty light 119

Oty light 119

Oty light 119

Oty light 119

Oty light 119

Oty light 119

Oty light 119

Oty light 119

Oty light 119

Oty light 119

Oty light 119

Oty light 119

Oty light 119

Oty light 119

Oty light 119

Oty light 119

Oty light 119

Oty light 119



#### **CREDITS**

*Graphic Concept* ..... Claudio Malvestio  
*Images*..... Mattia Cascione/Franco dell'Anno  
*Printing* ..... Grafiche Gemma  
*Copyright* ..... OTY s.r.l.  
*Printed in Italy* ..... June - 2022

*OTY SI RISERVA IL DIRITTO DI APPORTARE AL PROPRI MODELLI, SENZ'ALCUN PREAVVISO, QUALSIASI MODIFICA RITENESSE OPPORTUNA. TUTTI I MODELLI SONO DEPOSITATI.*

*OTY RESERVES THE RIGHT TO INTRODUCE ANY CHANGES TO ITS OWN MODELS, WITHOUT NOTICE IN ADVANCE. ALL MODELS HAVE BEEN DULY REGISTERED.*

*OTY BEHALT SICH DAS RECHT VOR ÄNDERUNGEN VORZUNEHMEN, OHNE SOFORTIGE BENCHRICHTIGUNG. ALLE MODELLE SIND EINGETRÄGEN.*

*OTY SE RÉSERVE LE DROIT D'APPORTER UNE QUELCONQUE MODIFICATION À LES MODÈLES SANS PRÉAVIS. TOUS NOUS MODÈLES SONT DÉPOSÉS.*

*OTY SE RESERVA EL DERECHO DE REALIZAR CUALQUIER MODIFICACIÓN SOBRE SUS MODELOS SIN PREVIO AVISO. TODOS LOS MODELOS HAN SIDO DEPOSITADOS.*

